

Specifications

Model	T-674C
Input Power	60W
Control Mode	Transformer
Signal Input	70~100V
Signal Output	0~100V
Speaker Type	Voltage Speaker
Frequency Response	80-16KHz
Step	11 Steps
Finish	ABS, white
Mounting Size	86x86x50mm
Dimension	86x90x68mm
Weight	0.20Kg
Accessory	One pair screw of M3.5x2.0

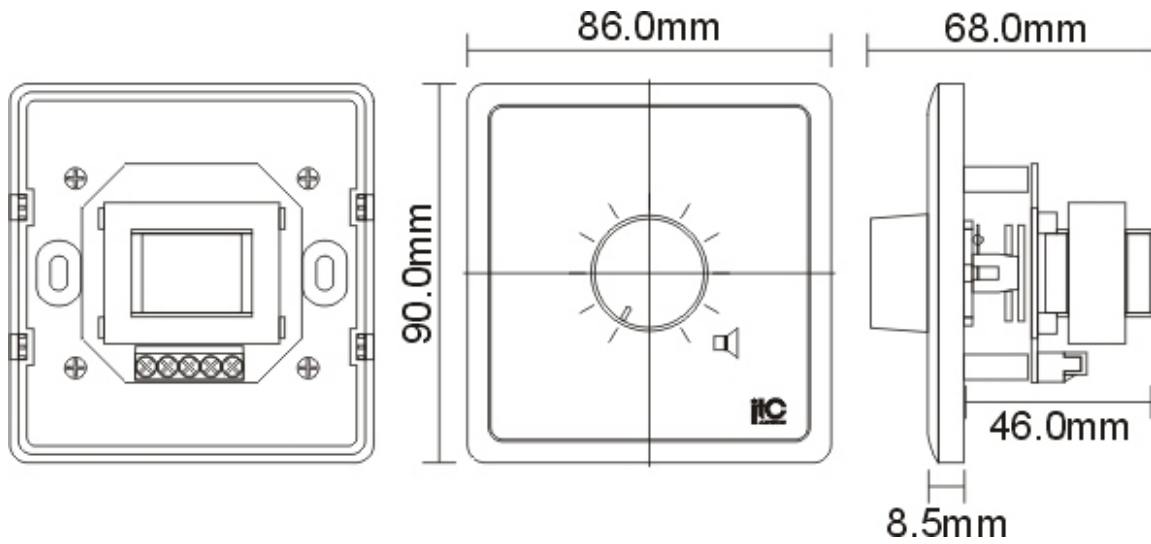

Connections

3 wired volume control wiring diagram

