



PUBLIC ADDRESS SYSTEM

OPERATION MANUAL

T-6245 DIGITAL MIXER 6 ZONE



Please follow the instructions in this manual to obtain the optimum results from this unit. We also recommend that you keep this manual handy for future reference.

TABLE OF CONTENTS

1. SAFETY PRECAUTIONS	3
2. GENERAL DESCRIPTION	5
3. FEATURES	5
4. NOMENCLATURE AND FUNCTIONS	
4.1 Front Panel	6
4.2 Rear Panel.....	7
5. CONNECTIONS	8
6. APPLICATIONS	9
7.ADDRESS SET	11
8.BLOCK DIAGRAM	13
9.SPECIFICATIONS	14
10.DIMENSIONAL DIAGRAM	15

SAFETY PRECAUTIONS

- Be sure to read the instructions in this section carefully before use.
- Make sure to observe the instructions in this manual as the conventions of safety symbols and messages regarded as very important precautions are included.
- We also recommend you keep this instruction manual handy for future reference.

Safety Symbol and Message Conventions

Safety symbols and messages described below are used in this manual to prevent bodily injury and property damage which could result from mishandling. Before operating your product, read this manual first and understand the safety symbols and messages so you are thoroughly aware of the potential safety



WARNING

Indicates a potentially hazardous situation which, if mishandled, could result in death or serious personal injury.



CAUTION

Indicates a potentially hazardous situation which, if mishandled, could result in moderate or minor personal injury, and/or property damage.



WARNING

When Installing the Unit

- Do not expose the unit to rain or an environment where it may be splashed by water or other liquids, as doing so may result in fire or electric shock.
- Use the unit only with the voltage specified on the unit. Using a voltage higher than that which is specified may result in fire or electric shock.
- Do not cut, kink, otherwise damage nor modify the power supply cord. In addition, avoid using the power cord in close proximity to heaters, and never place heavy objects -- including the unit itself -- on the power cord, as doing so may result in fire or electric shock.
- Be sure to replace the unit's terminal cover after connection completion. Because high voltage is applied to the speaker terminals, never touch these terminals to avoid electric shock.
- Be sure to ground to the safety ground (earth) terminal to avoid electric shock. Never ground to a gas pipe as a catastrophic disaster may result.
- Avoid installing or mounting the unit in unstable locations, such as on a rickety table or a slanted surface. Doing so may result in the unit falling down, causing personal injury and/or property damage.

When the Unit is in Use

- Should the following irregularity be found during use, immediately switch off the power, disconnect the power supply plug from the AC outlet and contact your nearest **ITC** dealer.
Make no further attempt to operate the unit in this condition as this may cause fire or electric shock.
 - If you detect smoke or a strange smell coming from the unit.
 - If water or any metallic object gets into the unit
 - If the unit falls, or the unit case breaks
 - If the power supply cord is damaged (exposure of the core, disconnection, etc.)
 - If it is malfunctioning (no tone sounds.)
- To prevent a fire or electric shock, never open nor remove the unit case as there are high voltage components inside the unit. Refer all servicing to your nearest **ITC** dealer.
- Do not place cups, bowls, or other containers of liquid or metallic objects on top of the unit. If they accidentally spill into the unit, this may cause a fire or electric shock.
- Do not insert nor drop metallic objects or flammable materials in the ventilation slots of the unit's cover, as this may result in fire or electric shock.

CAUTION

When Installing the Unit

- Never plug in nor remove the power supply plug with wet hands, as doing so may cause electric shock.
- When unplugging the power supply cord, be sure to grasp the power supply plug; never pull on the cord itself. Operating the unit with a damaged power supply cord may cause a fire or electric shock.
- When moving the unit, be sure to remove its power supply cord from the wall outlet. Moving the unit with the power cord connected to the outlet may cause damage to the power cord, resulting in fire or electric shock. When removing the power cord, be sure to hold its plug to pull.
- Do not block the ventilation slots in the unit's cover. Doing so may cause heat to build up inside the unit and result in fire.
- Avoid installing the unit in humid or dusty locations, in locations exposed to the direct sunlight, near the heaters, or in locations generating sooty smoke or steam as doing otherwise may result in fire or electric shock.

When the Unit is in Use

- Do not place heavy objects on the unit as this may cause it to fall or break which may result in personal injury and/or property damage. In addition, the object itself may fall off and cause injury and/or damage.
- Make sure that the volume control is set to minimum position before power is switched on. Loud noise produced at high volume when power is switched on can impair hearing.
- Do not operate the unit for an extended period of time with the sound distorting. This is an indication of a malfunction, which in turn can cause heat to generate and result in a fire.
- Contact your **ITC** dealer as to the cleaning. If dust is allowed to accumulate in the unit over a long period of time, a fire or damage to the unit may result.
- If dust accumulates on the power supply plug or in the wall AC outlet, a fire may result. Clean it periodically. In addition, insert the plug in the wall outlet securely.
- Switch off the power, and unplug the power supply plug from the AC outlet for safety purposes when cleaning or leaving the unit unused for 10 days or more. Doing otherwise may cause a fire or electric shock.

An all-pole mains switch with a contact separation of at least 3 mm in each pole shall be incorporated in the electrical installation of the building.

2. GENERAL DESCRIPTION

T-6245 is a digital 6 zone mixer can provide an ideal public address solution from small to big places such as mosques, schools, hotels and factories to train stadium and air stations.

3. FEATURES

1. 6 zones sources selection and control function.
2. 6 zones alarming sources selection control with 24VDC output.
3. Build-in 3 record storage, can setting freely to play.
4. Build-in chime generator.
5. 3 CH sources input: 1 CH MIC input, build-in optional control, build-in optional control+48V phantom power.
6. 3 CH preamp output :MUSIC,MUSIC PAGE,PAGE pre output.
7. 3 Classes priority.
 - a:Build-in record message (1and 2) Priority: TUNER,CD,MP3.
 - b:Build-in chime priority: record message(1and 2): TUNER,CD,MP3.
 - c: Select paging MIC override all audio sources.
9. Build-in voltage output indicator.
- 10.485 COM port.

4. NOMENCLATURE AND FUNCTIONS

4.1 FRONT PANEL

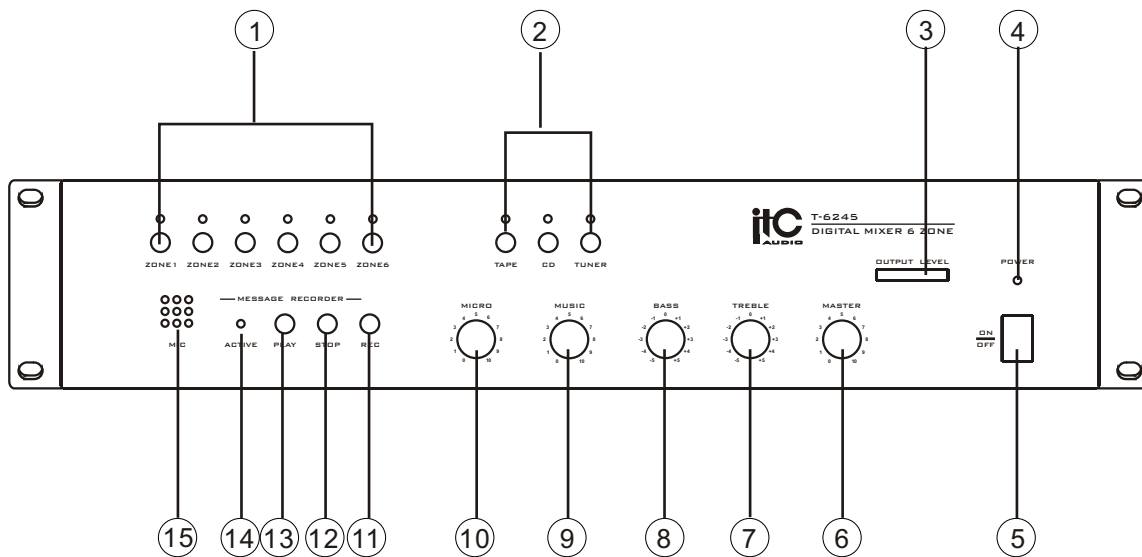

1. ZONE(1~6)

N.6 buttons for music selection In the 6 different zones

2. AUDIO

N.3 key switch for input channel selection:

Tape、CD、Tuner

3. OUTPUT LEVEL

Signal level indicator

4. POWER

Power indicator

5. POWER SWITCH

On top of the opening Power

Press the end, power shut down

6. MASTER

Master level control

7. TREBLE

Adjust treble response. Rotate clockwise to increase treble output and anticlockwise to reduce it.

8. BASS

Adjust bass response. Rotate clockwise to increase bass output and anticlockwise to reduce it.

9. MUSIC

Music volume control

10.MICRO

MICRO volume control

11.REC

Key switch Rec message

Three messages of 60 seconds each could be recorded; for message selection see switch(13) on rear Panel.

12.STOP

Key switch stop message

13.PLAY

Key switch play message for manual activation

14.ACTIVE

Indicator play message

15.MIC

Internal microphone for message recording

4.2 REAR PANEL

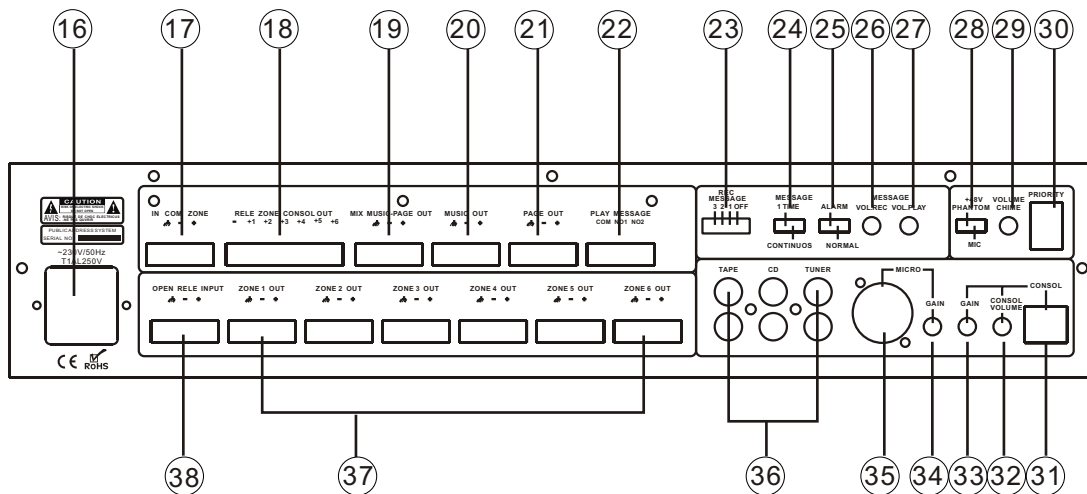

16.AC INLET

Connect to the supplied power cord.

17.IN COMMON RELE MUSIC ZONE

18.OUT POWER CONTROL RELE

19.OUT MIX MUSIC PAGE VOICE

20.OUT SIGNAL MUSIC

21.OUT SIGNAL PAGE

22.CONTACT PLAY MESSAGE 1 OR 2

The third message is activated by Microphone basedirectly.

23. SWITCH REC MESSAGE:

OFF, 1, 2, 3 .

This is used to select the message to record

24. SWSWITCH MESSAGE 1 TIME / CONTINUOUS

- 1 TIME:

The recorded message plays only Once

- CONTINUOUS:

The recorded message plays continuously till the message contact is kept closed.

25. SWITCH MICROPHONE ALARM / NORMAL THE MIXER COULD WORK WITHOUT MICROPHONE CONSOLE BMD6; A SIMPLE MICROPHONE BASE WITH PRIORITY CONTACT COULD BE CONNECTED TO XLR MICROPHONE INPUT).

- ALARM:

The voice is simultaneously distributed in all the 6 zones

- NORMAL:

The voice is distributed only in the zone selected with front panel Buttons

26. VOLUME REC MESSAGE

27. VOLUME PLAYMESSAGE

28. PHANTOM POWER SELECT SWITCH

29. CHIME VOLUME CONTROL

30. PRIORITY CONTROL PORT FOR BGM AND INTERNAL CHIME.

31. INPUT RJ45 CONSOL

Max 6 microphone bases in Parallel

32. VOLUME INPUT CONSOL

33. CONSOL GAIN CONTROL

34. MICROPHONE GAIN CONTROL

35. MICROPHONE INPUT XLR BALANCED

36. AUDIO SOURCE INTERFACE

37. OUT ZONE (1~6)

38. INPUT CONTACT OPEN RELE ZONE

5. CONNECTIONS

■ NETWORK CONNECTION LINE

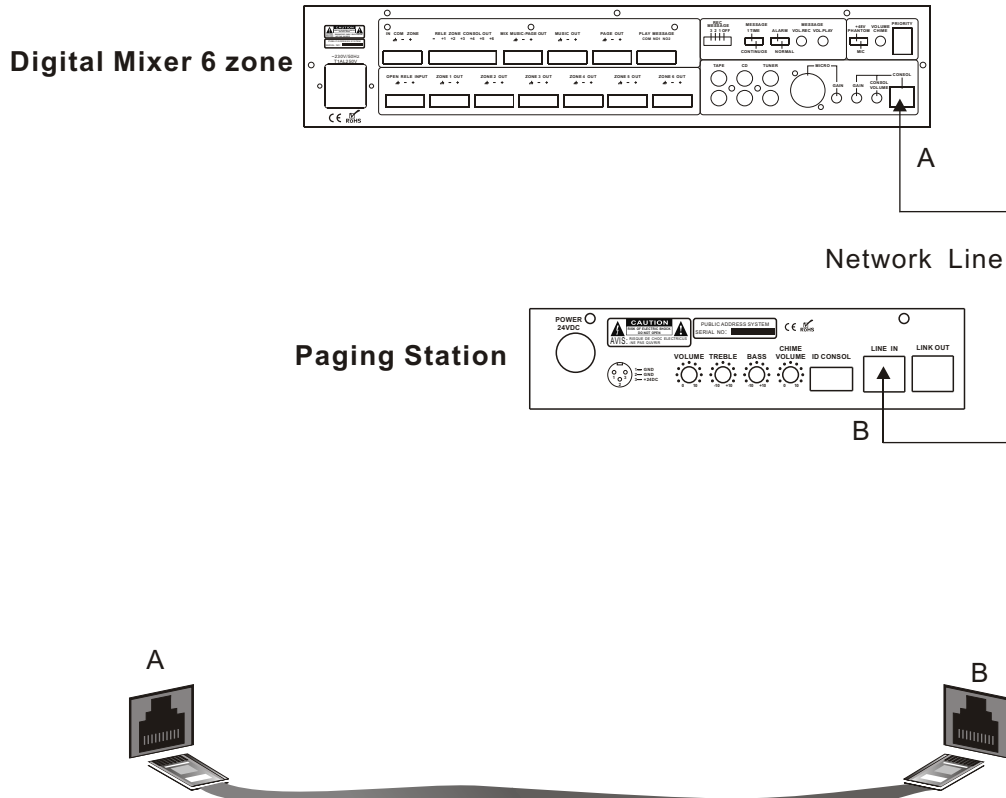

■ NET PRODUCTION LINE METHOD



A: 1 Blue 2 White/Blue 3 Brown 4 White/Brown 5 Orange 6 White/Orange
7 Green 8 White/Green

B: 1 Blue 2 White/Blue 3 Brown 4 White/Brown 5 Orange 6 White/Orange
7 Green 8 White/Green

⚠ Note: Network lines must adopt the five categories of twisted-pair with double-layer shielding, RJ45 connectors must be used with shielded connector.





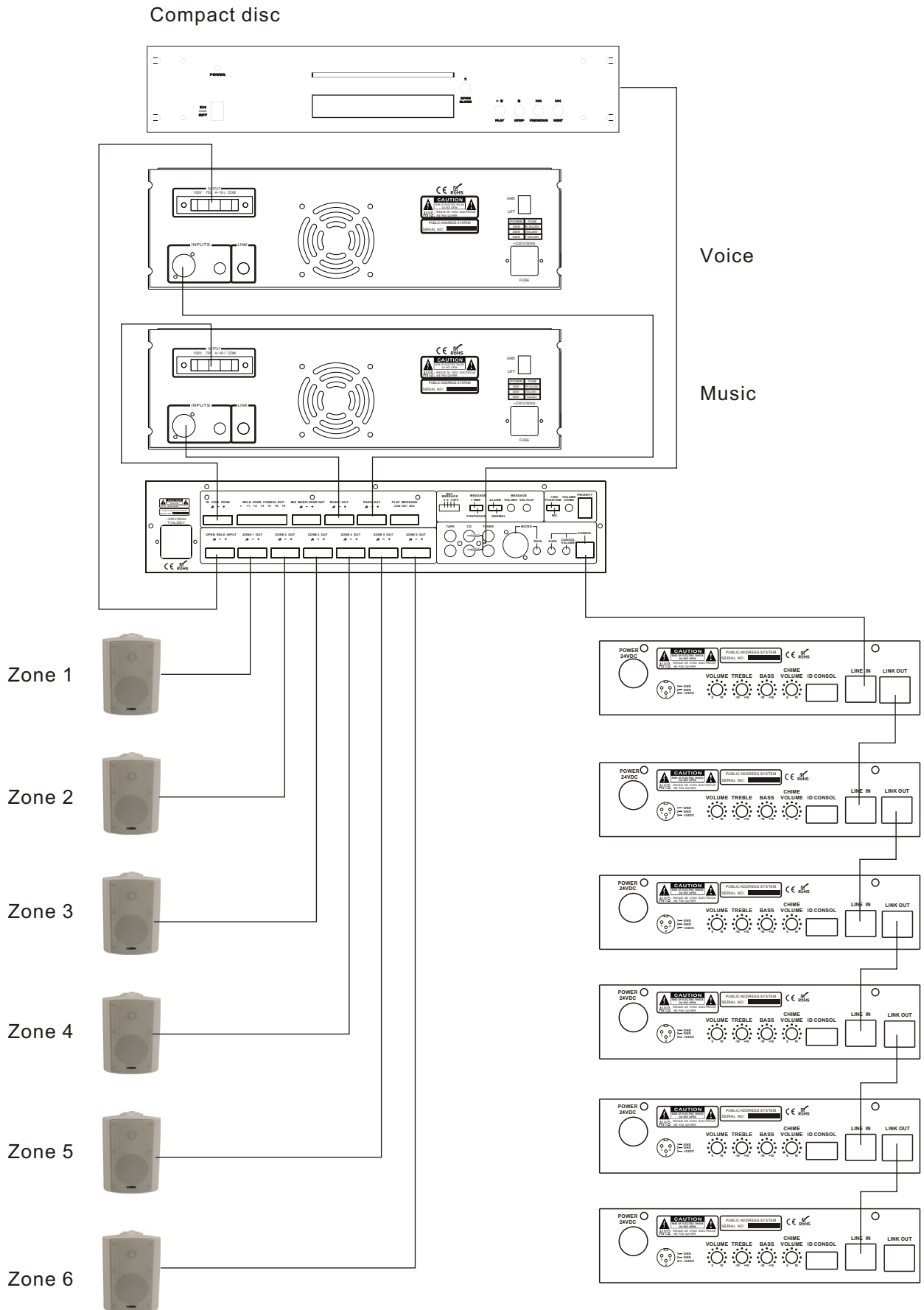

6. APPLICATIONS



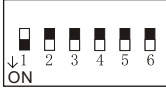
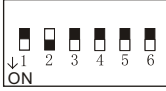
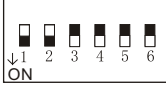

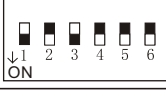
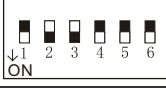
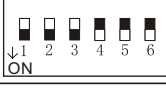

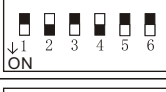
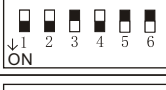
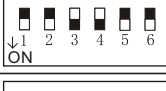
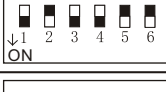
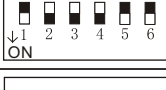
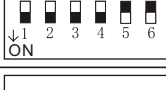

1 amplifier for music 1 amplifier for voice for 6 zone



7.ADDRESS SET

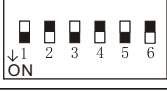
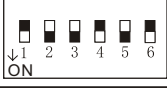
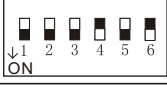
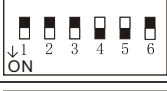
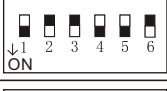
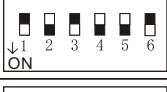
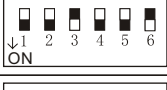
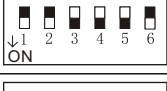
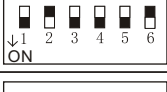

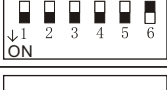

ID CONSOL ADDRESS SET





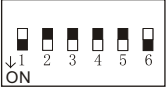
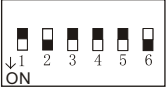
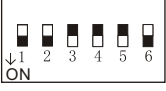
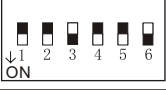
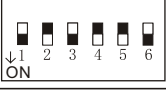
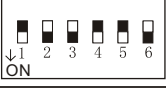
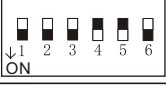

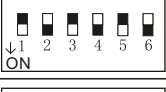
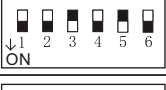
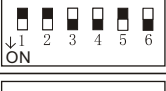
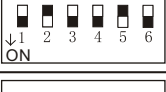
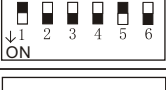
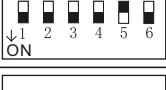

ADDRESS	DEFINITION
1	
2	
3	
4	
5	
6	
7	
8	
9	
10	
11	
12	
13	
14	
15	
16	

ADDRESS	DEFINITION
17	
18	
19	
20	
21	
22	
23	
24	
25	
26	
27	
28	
29	
30	
31	
32	

ADDRESS SET

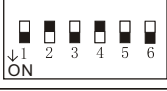
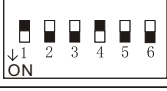
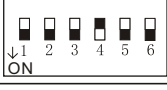
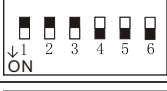
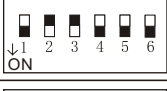
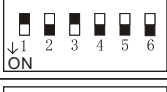
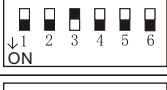
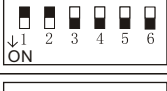
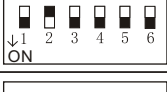
ID CONSOL ADDRESS SET

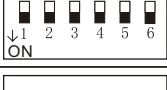
ADDRESS	DEFINITION
33	
34	
35	
36	
37	
38	
39	
40	
41	
42	
43	
44	
45	
46	
47	
48	

ADDRESS	DEFINITION
49	
50	
51	
52	
53	
54	
55	
56	
57	
58	
59	
60	
61	
62	
63	
64	

7. BLOCK DIAGRAM

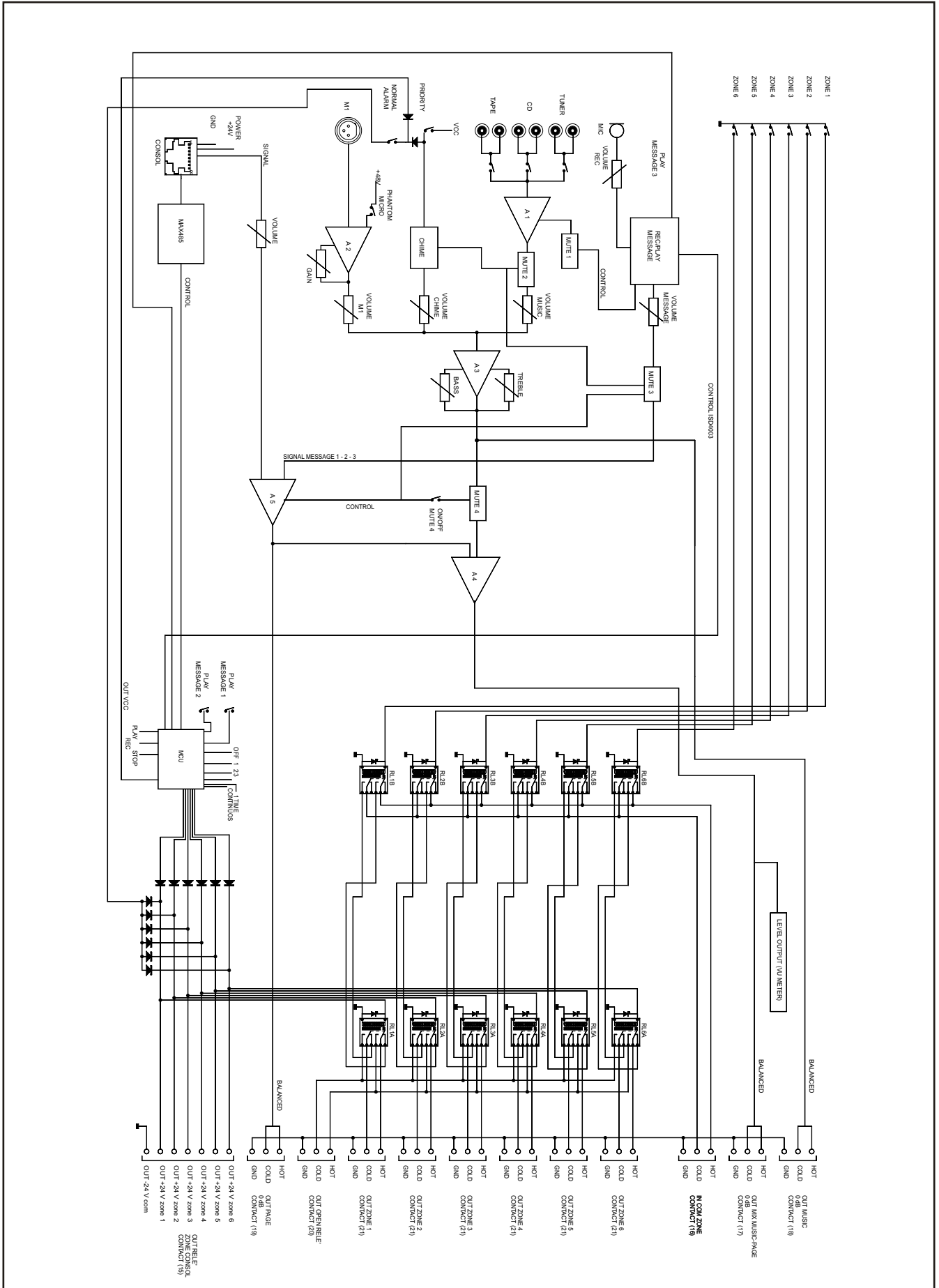

8. SPECIFICATIONS

Model	T-6245
Consol input	
Sensitivity	-50 / -2 dB 2, 5 / 500 mV
S/N ratio	>68dB
Frequency response	100/17.000Hz(-3dB)
1 Mircophone input	
Sensitivity	-50 / -2 dB 2, 5 / 500 mV
S/N ratio	>68dB
Frequency response	100/17.000Hz(-3dB)
Phantom power	48V
3 Auxiliary inputs	
Tuner and Tape input sensitivity / impedance	200 mV / 47 Kohm
CD input sensitivity / impedance	500 mV / 47 Kohm
S/N ratio	>90 dB
Frequency response	40/20.000Hz(-3dB)
Control	
Bass	± 12dB
Treble	± 12dB
Chime	2 tone active for contact free in priority and BGM
Normal distortion	>0.1%
Operating condition	
Main power supply	230 V/ 50 Hz
Dimension(mm)	484X322X88
Weight	6.58Kg
Max number of microphone bases	6

9. DIMENSIONAL DIAGRAM

UNIT :mm

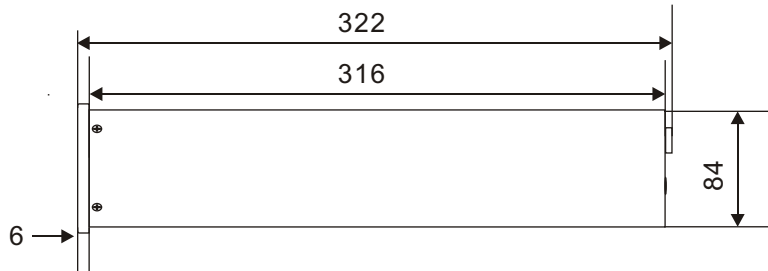
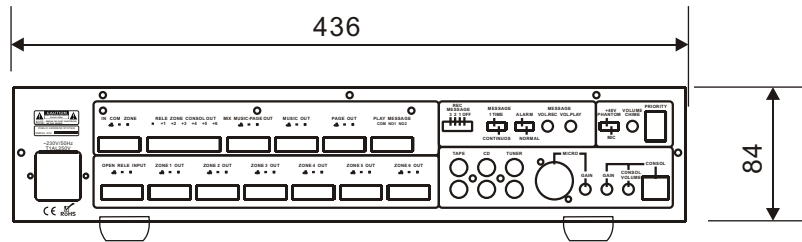
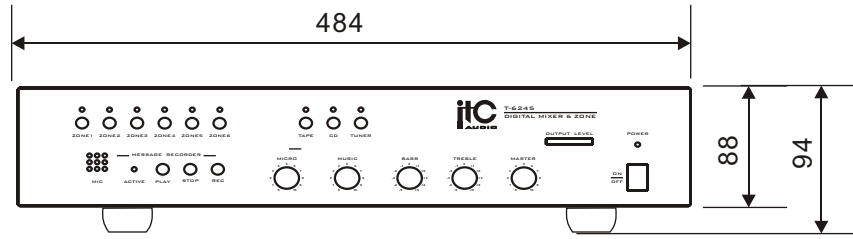

Keep the unit's all sides over 10 cm away from objects that may obstruct air flow to prevent the unit's internal temperature rise.

UNIT :mm

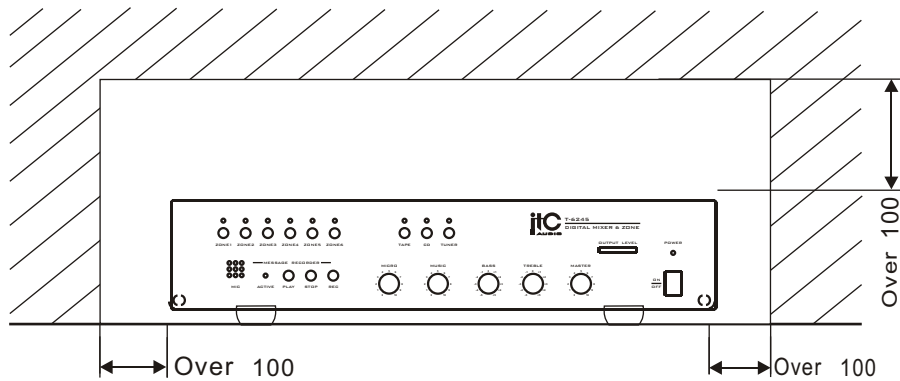

PUBLIC ADDRESS SYSTEM

