

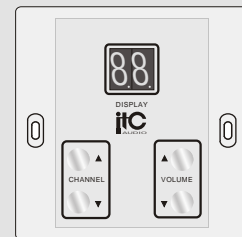

PUBLIC ADDRESS SYSTEM

OPERATION MANUAL

T-6207S STEREO 6x6 AUDIO MATRIX



Please follow the instructions in this manual to obtain the optimum results from this unit. We also recommend that you keep this manual handy for future reference.

TABLE OF CONTENTS

1. SAFETY PRECAUTIONS	3
2. GENERAL DESCRIPTION	5
3. FEATURES	5
4. NOMENCLATURE AND FUNCTIONS	
4.1 Front Panel	6
4.2 Rear Panel.....	7
4.3 Front Panel.....	7
4.4 Rear Panel.....	7
5. OPERATION	8
6. APPLICATIONS	9
7. SPECIFICATIONS	10
8. DIMENSIONAL DIAGRAM	11

1. SAFETY PRECAUTIONS

- Be sure to read the instructions in this section carefully before use.
- Make sure to observe the instructions in this manual as the conventions of safety symbols and messages regarded as very important precautions are included.
- We also recommend you keep this instruction manual handy for future reference.

Safety Symbol and Message Conventions

Safety symbols and messages described below are used in this manual to prevent bodily injury and property damage which could result from mishandling. Before operating your product, read this manual first and understand the safety symbols and messages so you are thoroughly aware of the potential safety



WARNING

Indicates a potentially hazardous situation which, if mishandled, could result in death or serious personal injury.



CAUTION

Indicates a potentially hazardous situation which, if mishandled, could result in moderate or minor personal injury, and/or property damage.



WARNING

When Installing the Unit

- Do not expose the unit to rain or an environment where it may be splashed by water or other liquids, as doing so may result in fire or electric shock.
- Use the unit only with the voltage specified on the unit. Using a voltage higher than that which is specified may result in fire or electric shock.
- Do not cut, kink, otherwise damage nor modify the power supply cord. In addition, avoid using the power cord in close proximity to heaters, and never place heavy objects -- including the unit itself -- on the power cord, as doing so may result in fire or electric shock.
- Be sure to replace the unit's terminal cover after connection completion. Because high voltage is applied to the speaker terminals, never touch these terminals to avoid electric shock.
- Be sure to ground to the safety ground (earth) terminal to avoid electric shock. Never ground to a gas pipe as a catastrophic disaster may result.
- Avoid installing or mounting the unit in unstable locations, such as on a rickety table or a slanted surface. Doing so may result in the unit falling down, causing personal injury and/or property damage.

When the Unit is in Use

- Should the following irregularity be found during use, immediately switch off the power, disconnect the power supply plug from the AC outlet and contact your nearest **ITC** dealer. Make no further attempt to operate the unit in this condition as this may cause fire or electric shock.
 - If you detect smoke or a strange smell coming from the unit.
 - If water or any metallic object gets into the unit
 - If the unit falls, or the unit case breaks
 - If the power supply cord is damaged (exposure of the core, disconnection, etc.)
 - If it is malfunctioning (no tone sounds.)
- To prevent a fire or electric shock, never open nor remove the unit case as there are high voltage components inside the unit. Refer all servicing to your nearest **ITC** dealer.
- Do not place cups, bowls, or other containers of liquid or metallic objects on top of the unit. If they accidentally spill into the unit, this may cause a fire or electric shock.
- Do not insert nor drop metallic objects or flammable materials in the ventilation slots of the unit's cover, as this may result in fire or electric shock.

1. SAFETY PRECAUTIONS

CAUTION

When Installing the Unit

- Never plug in nor remove the power supply plug with wet hands, as doing so may cause electric shock.
- When unplugging the power supply cord, be sure to grasp the power supply plug; never pull on the cord itself. Operating the unit with a damaged power supply cord may cause a fire or electric shock.
- When moving the unit, be sure to remove its power supply cord from the wall outlet. Moving the unit with the power cord connected to the outlet may cause damage to the power cord, resulting in fire or electric shock. When removing the power cord, be sure to hold its plug to pull.
- Do not block the ventilation slots in the unit's cover. Doing so may cause heat to build up inside the unit and result in fire.
- Avoid installing the unit in humid or dusty locations, in locations exposed to the direct sunlight, near the heaters, or in locations generating sooty smoke or steam as doing otherwise may result in fire or electric shock.

When the Unit is in Use

- Do not place heavy objects on the unit as this may cause it to fall or break which may result in personal injury and/or property damage. In addition, the object itself may fall off and cause injury and/or damage.
- Make sure that the volume control is set to minimum position before power is switched on. Loud noise produced at high volume when power is switched on can impair hearing.
- Do not operate the unit for an extended period of time with the sound distorting. This is an indication of a malfunction, which in turn can cause heat to generate and result in a fire.
- Contact your **ITC** dealer as to the cleaning. If dust is allowed to accumulate in the unit over a long period of time, a fire or damage to the unit may result.
- If dust accumulates on the power supply plug or in the wall AC outlet, a fire may result. Clean it periodically. In addition, insert the plug in the wall outlet securely.
- Switch off the power, and unplug the power supply plug from the AC outlet for safety purposes when cleaning or leaving the unit unused for 10 days or more. Doing otherwise may cause a fire or electric shock.

An all-pole mains switch with a contact separation of at least 3 mm in each pole shall be incorporated in the electrical installation of the building.

2. GENERAL DESCRIPTION

T-6207S Series ITC Audio matrix functions applicable to the design, such as the family, schools, offices, shops and other establishments have Broadcasting System.

3. FEATURES

- 16 into 8-channel matrix signal.
- Each output corresponding to each input can be preset volume changes in the input lines automatically preset, balanced input signal.

4. NOMENCLATURE AND FUNCTIONS

4.1 FRONT PANEL

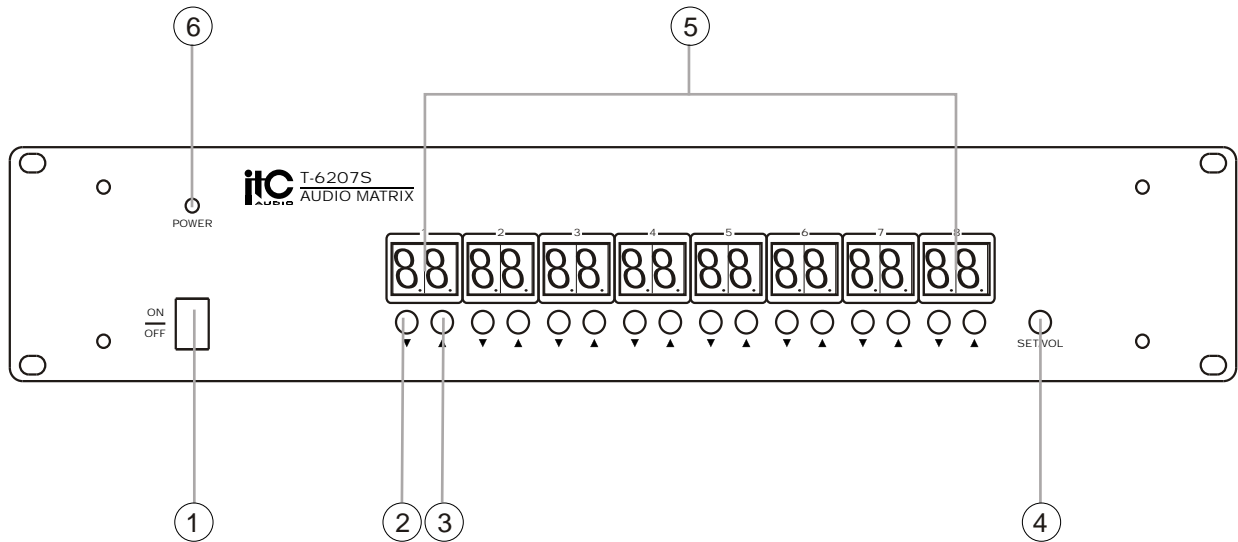

1. POWER SWITCH

On top of the opening Power
Press the end, power shut down

2. CHANNEL BUTTON

Line / volume reduction

3. CHANNEL BUTTON

Line / volume increase

4. SETVOL

Setting / adjust the volume option

5. DISPLAY

Other equipment channel and volume

6. POWER

Power indicator

NOMENCLATURE AND FUNCTIONS

4.2 REAR PANEL

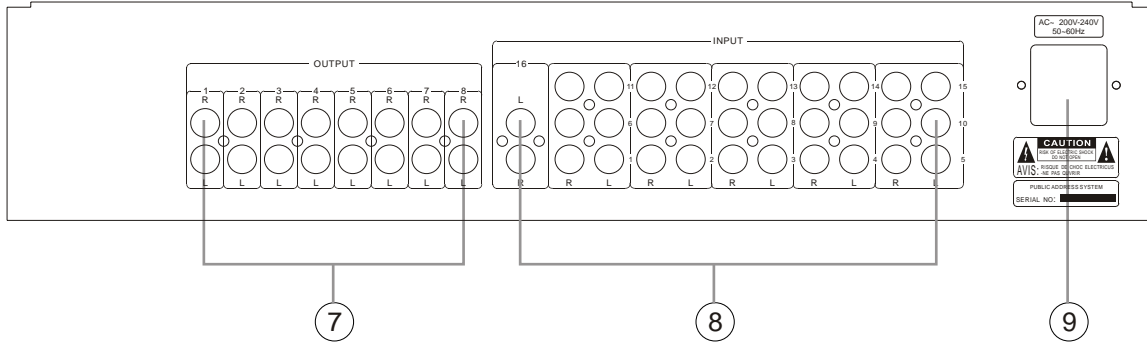

7. OUTPUT(CH1~CH8)

Audio source output (CH1~ CH8)
(CH1 ~ CH8) stereo audio source is
Connected with the amplifier

8. INPUT (CH1~CH8)

Audio source input (CH1~ CH8)
(CH1 ~ CH8) signal input terminal
9.~220V/50Hz AC POWER INPUT

4.3 FRONT PANEL

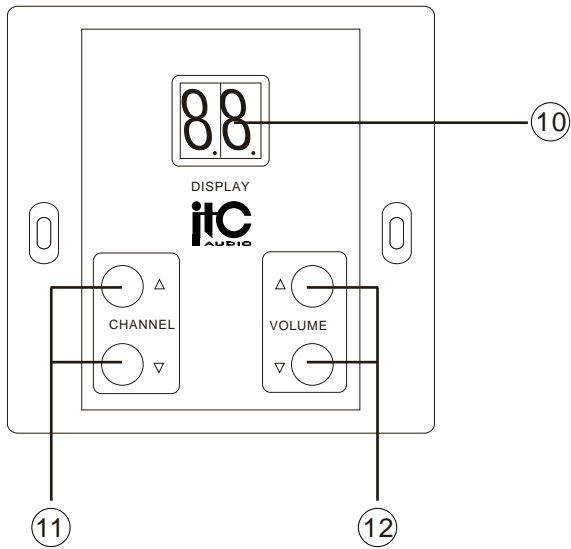

10.DISPLAY

Channel volume display

11.CHANNEL

Channel adjustment buttons

12.VOLUME

Adjust the volume buttons

4.4 REAR PANEL

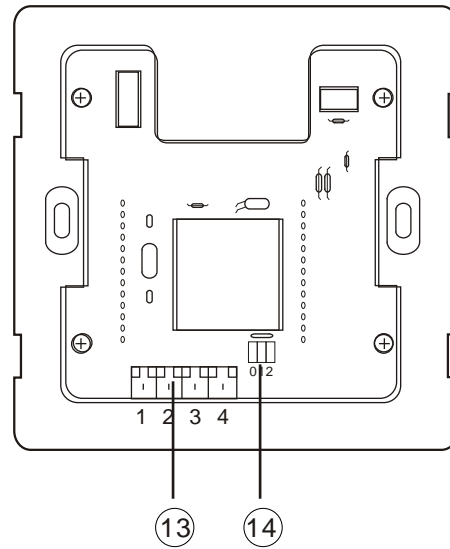

13.CONNECTOR

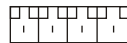

1 2 3 4



1.GND 2.+5V 3.B 4.A

14.ADDRESS CODE SET

5. OPERATION

1. APRESET VOLUME





T-6207S to balance the input levels resulting from the different regions in the music source switching caused by the volume change , In advance of each Input and output volume preset combinations. Operation is as follows :

- Press SET / VOL button
- Open machines power
- Were set up for each output corresponding to the input of each volume, the use of  
- Set up an End of an import export volume, according to SET / VOL input into the next one.
- End were set up 16 imported.
- Turn off the power, reset button and set up force.

- Note:
1. Lines must be in strict accordance with the above this figure wiring, or they will not achieve the functional machine control.
 2. The line volume selector should separate power supply.

2.THE USE OF TWO PANELS CLICK ON THE INPUT LINES AND THE VOLUME

T-6207S to balance the input levels resulting from the different regions in the music source switching caused by the volume change , In advance of each Input and output volume preset combinations. Operation is as follows :

- When monitors showed no decimal places, with   key switch input signals.
- When the right of the decimal display at the show, with   key changes in the volume switch.
- Use of SET / VOL switch.

3. REMOTE CONTROLLER

Using remote controller on the CH + and CH- VOL +, VOL - controlled areas of the music signal and noise.

The eight-channel devices at the same time adjustment function.

■ ADDRESS

1:

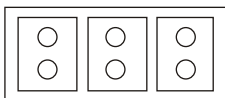

5:

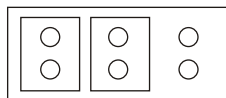

2:

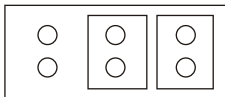

6:

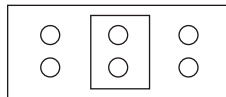

3:

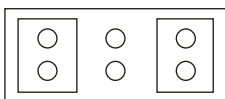

7:

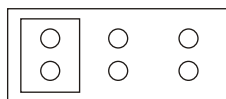

4:

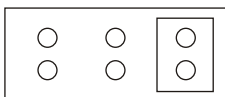

8:

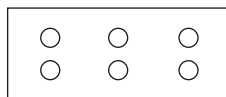

6. APPLICATIONS

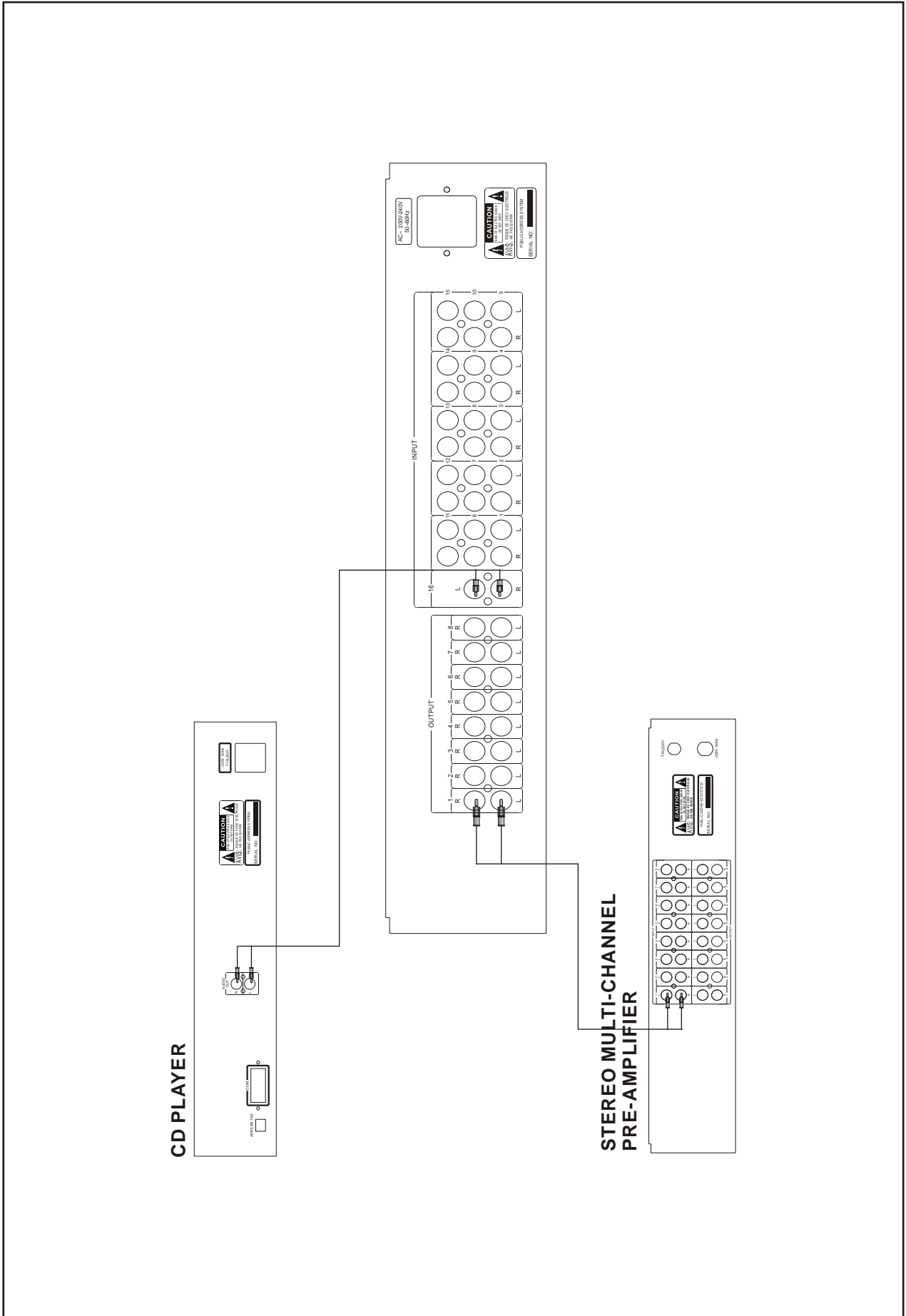

7. SPECIFICATIONS

STEREO 6x6 AUDIO MATRIX	
MODEL	T-6207S
AUDIO CHANNELS	16 CH stereo input, 8 CH stereo output
CONTROL	Key switch
INDICATOR	LEDs
PROTECTION	AC FUSE, 1A
POWER REQUIREMENTS	~220V/50Hz
POWER CONSUMPTION	25W
DIMENSION(mm)	484X370X88
NET WEIGHT	4.1Kg
GROSS WEIGHT	5.3Kg

8. DIMENSIONAL DIAGRAM

UNIT :mm

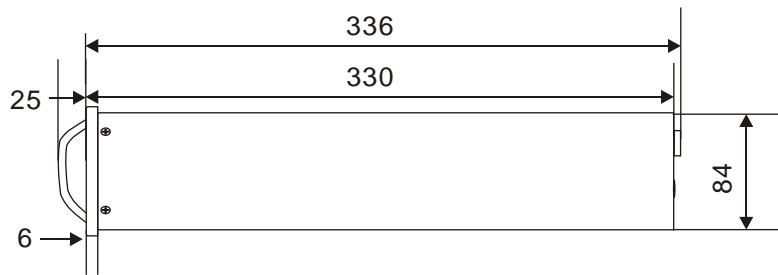
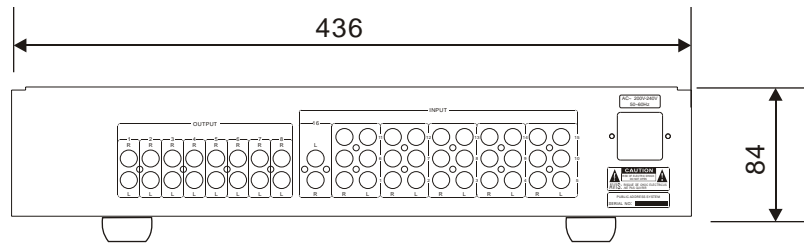
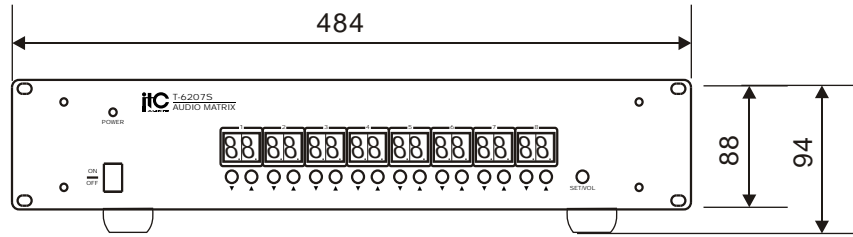

Keep the unit's all sides over 10 cm away from objects that may obstruct air flow to prevent the unit's internal temperature rise.

UNIT :mm

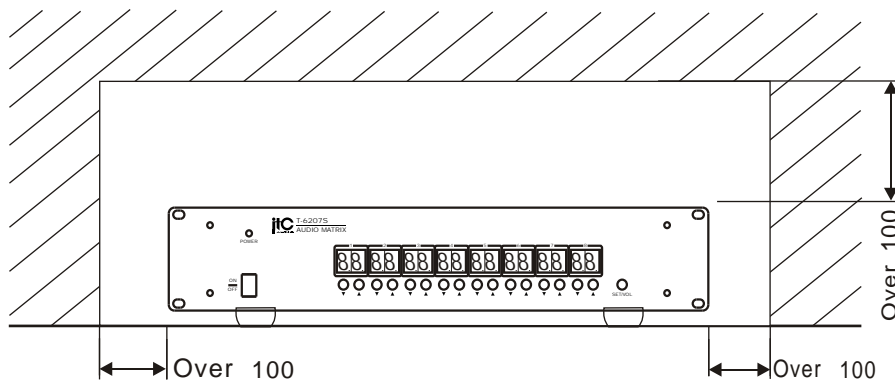

PUBLIC ADDRESS SYSTEM



Guangzhou ITC Electronic Technology Limited
[Http://www.itc-pa.com.cn](http://www.itc-pa.com.cn)