

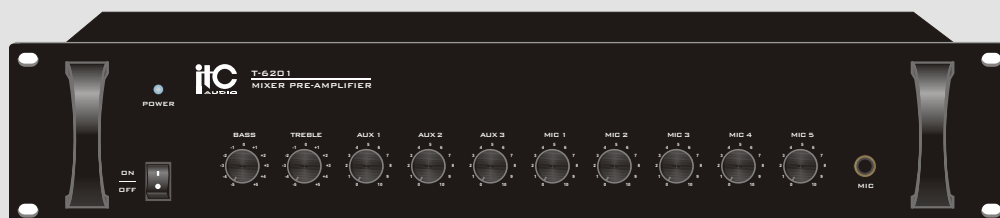

PUBLIC ADDRESS SYSTEM

OPERATION MANUAL

T-6201 MIXER PRE-AMPLIFIER



Please follow the instructions in this manual to obtain the optimum results from this unit. We also recommend that you keep this manual handy for future reference.

TABLE OF CONTENTS

1. SAFETY PRECAUTIONS	3
2. GENERAL DESCRIPTION	5
3. FEATURES	5
4. NOMENCLATURE AND FUNCTIONS	
4.1 Front Panel	6
4.2 Rear Panel.....	7
5.MACHINE OPERATING	8
6.APPLICATIONS	9
7.BLOCK DIAGRAM	10
8.SPECIFICATIONS	11
9.DIMENSIONAL DIAGRAM	12

1. SAFETY PRECAUTIONS

- Be sure to read the instructions in this section carefully before use.
- Make sure to observe the instructions in this manual as the conventions of safety symbols and messages regarded as very important precautions are included.
- We also recommend you keep this instruction manual handy for future reference.

Safety Symbol and Message Conventions

Safety symbols and messages described below are used in this manual to prevent bodily injury and property damage which could result from mishandling. Before operating your product, read this manual first and understand the safety symbols and messages so you are thoroughly aware of the potential safety



WARNING

Indicates a potentially hazardous situation which, if mishandled, could result in death or serious personal injury.



CAUTION

Indicates a potentially hazardous situation which, if mishandled, could result in moderate or minor personal injury, and/or property damage.



WARNING

When Installing the Unit

- Do not expose the unit to rain or an environment where it may be splashed by water or other liquids, as doing so may result in fire or electric shock.
- Use the unit only with the voltage specified on the unit. Using a voltage higher than that which is specified may result in fire or electric shock.
- Do not cut, kink, otherwise damage nor modify the power supply cord. In addition, avoid using the power cord in close proximity to heaters, and never place heavy objects -- including the unit itself -- on the power cord, as doing so may result in fire or electric shock.
- Be sure to replace the unit's terminal cover after connection completion. Because high voltage is applied to the speaker terminals, never touch these terminals to avoid electric shock.
- Be sure to ground to the safety ground (earth) terminal to avoid electric shock. Never ground to a gas pipe as a catastrophic disaster may result.
- Avoid installing or mounting the unit in unstable locations, such as on a rickety table or a slanted surface. Doing so may result in the unit falling down, causing personal injury and/or property damage.

When the Unit is in Use

- Should the following irregularity be found during use, immediately switch off the power, disconnect the power supply plug from the AC outlet and contact your nearest **ITC** dealer. Make no further attempt to operate the unit in this condition as this may cause fire or electric shock.
 - If you detect smoke or a strange smell coming from the unit.
 - If water or any metallic object gets into the unit
 - If the unit falls, or the unit case breaks
 - If the power supply cord is damaged (exposure of the core, disconnection, etc.)
 - If it is malfunctioning (no tone sounds.)
- To prevent a fire or electric shock, never open nor remove the unit case as there are high voltage components inside the unit. Refer all servicing to your nearest **ITC** dealer.
- Do not place cups, bowls, or other containers of liquid or metallic objects on top of the unit. If they accidentally spill into the unit, this may cause a fire or electric shock.
- Do not insert nor drop metallic objects or flammable materials in the ventilation slots of the unit's cover, as this may result in fire or electric shock.

CAUTION

When Installing the Unit

- Never plug in nor remove the power supply plug with wet hands, as doing so may cause electric shock.
- When unplugging the power supply cord, be sure to grasp the power supply plug; never pull on the cord itself. Operating the unit with a damaged power supply cord may cause a fire or electric shock.
- When moving the unit, be sure to remove its power supply cord from the wall outlet. Moving the unit with the power cord connected to the outlet may cause damage to the power cord, resulting in fire or electric shock. When removing the power cord, be sure to hold its plug to pull.
- Do not block the ventilation slots in the unit's cover. Doing so may cause heat to build up inside the unit and result in fire.
- Avoid installing the unit in humid or dusty locations, in locations exposed to the direct sunlight, near the heaters, or in locations generating sooty smoke or steam as doing otherwise may result in fire or electric shock.

When the Unit is in Use

- Do not place heavy objects on the unit as this may cause it to fall or break which may result in personal injury and/or property damage. In addition, the object itself may fall off and cause injury and/or damage.
- Make sure that the volume control is set to minimum position before power is switched on. Loud noise produced at high volume when power is switched on can impair hearing.
- Do not operate the unit for an extended period of time with the sound distorting. This is an indication of a malfunction, which in turn can cause heat to generate and result in a fire.
- Contact your **ITC** dealer as to the cleaning. If dust is allowed to accumulate in the unit over a long period of time, a fire or damage to the unit may result.
- If dust accumulates on the power supply plug or in the wall AC outlet, a fire may result. Clean it periodically. In addition, insert the plug in the wall outlet securely.
- Switch off the power, and unplug the power supply plug from the AC outlet for safety purposes when cleaning or leaving the unit unused for 10 days or more. Doing otherwise may cause a fire or electric shock.

An all-pole mains switch with a contact separation of at least 3 mm in each pole shall be incorporated in the electrical installation of the building.

2. GENERAL DESCRIPTION

The T-6201 is a public address pre-amplifier with ten inputs-five unbalanced MIC inputs, three AUX level input and two EMC (priority) level inputs.

3. FEATURES

1. Five MIC inputs.
2. Three AUX inputs.
3. Two EMC priority input.
4. Two stereo aux input and two line input.
5. EMC 1 input with priority over all other inputs except MIC 5.
6. AUX, MIC, Tuner, Bass, Treble volume control.

4. NOMENCLATURE AND FUNCTIONS

4.1 FRONT PANEL

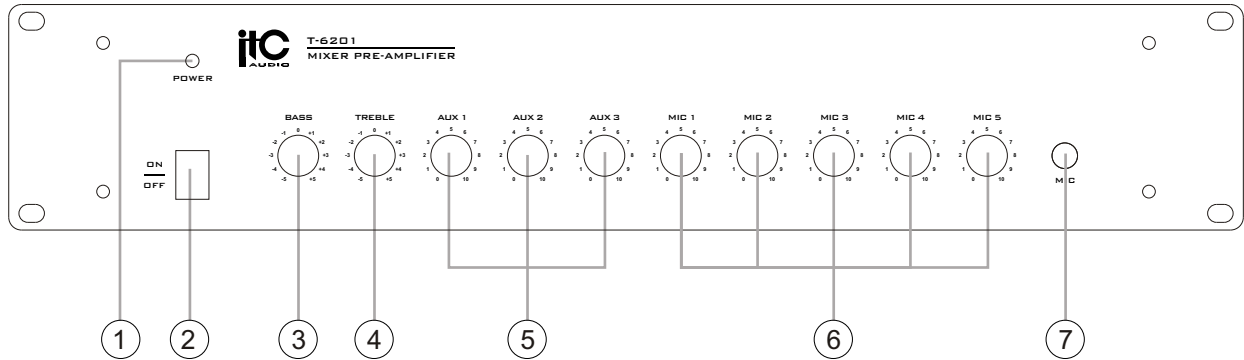

1. POWER

Power indicator

2. POWER SWITCH

On top of the opening Power

Press the end, power shut down

3. BASS

Adjust bass response. Rotate clockwise to increase bass output and anticlockwise to reduce it.

4. TREBLE

Adjust treble response. Rotate clockwise to increase treble output and anticlockwise to reduce it.

5. AUX1 \ AUX2 \ AUX3

AUX volume control(AUX 1/AUX 2/AUX3)

6. MIC(1~5)

MIC volume control (MIC(1~5))

7. MIC

MIC1 input 6.3 Microphone jack input

4.2 REAR PANEL

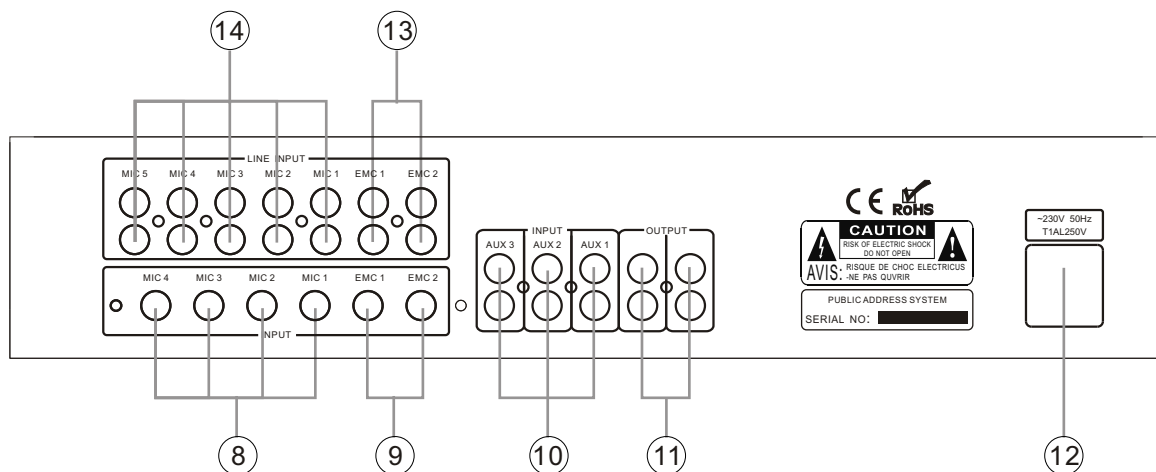

8. INPUT

MIC Balanced inputs(MIC1\MIC2\MIC3\MIC4)

9. INPUT

EMC Input Fire alarm signal input(EMC1\EMC2)

10.INPUT

Auxiliary input jack, Non-equilibrium of connecting peripherals signal(AUX1\AUX2\AUX3)

11.OUT

Line output, Non-equilibrium type, the output of all input signals.

12.~230V/50Hz AC POWER INPUT

13.LINE INPUT

EMC(1~2) Input Fire alarm signal input

14.LINE INPUT

MIC Balanced inputs(MIC(1~5))

5. MACHINE OPERATION

MUTING FUNCTION

The MIC input 1、 2、 3、 4 and AUX input1、 2、 3 automatically muted by EMCinput 1、 2.(EMC 1 or 2 input overrides the MIC1、 2、 3、 4 and AUX 1、 2、 3 signals).

The MIC input 1、 2、 3、 4 AUX input 1、 2、 3 and EMC 1、 2 are automaticallymuted by MIC input 1 (MIC 5 input overrides the other input signals).

7. BLOCK DIAGRAM

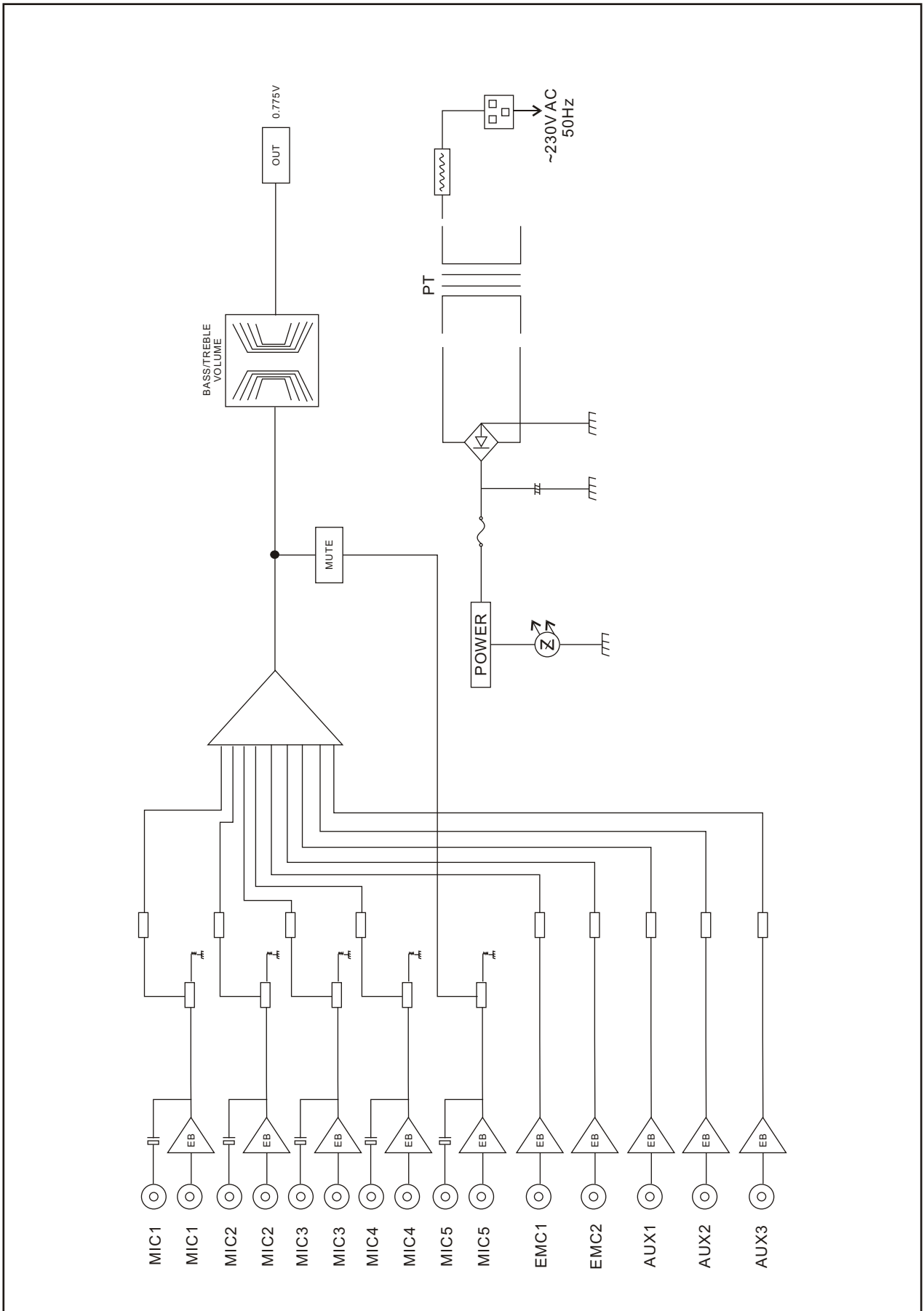

8.SPECIFICATIONS

MIXER PRE-AMPLIFIER	
MODEL	T-6201
INPUT	MIC 1.2.3.4.5: 600ohms 1.8mv unbalanced AUX 1.2.3:10Kohms 200mv unbalanced
OUTPUT	600 ohms 1V 0dBV
FREQUENCY RESPONSE	20Hz~20KHz
SIGNAL/NOISE RATIO	MIC input: 80dB AUX input: 85dB
TONE	Bas : ± 10 dB at 100Hz Treble: ± 10 dB at 15kHz
PROTECTION	AC fusex1
POWER REQUIREMENTS	~230V/50Hz
DIMENSION(mm)	484X353X88
NET WEIGHT	8Kg
GROSS WEIGHT	9Kg

9. DIMENSIONAL DIAGRAM

UNIT :mm

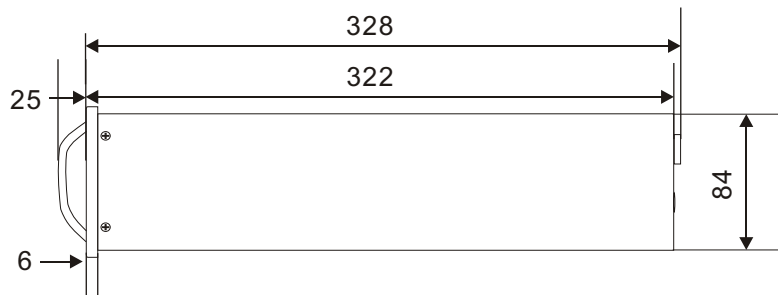
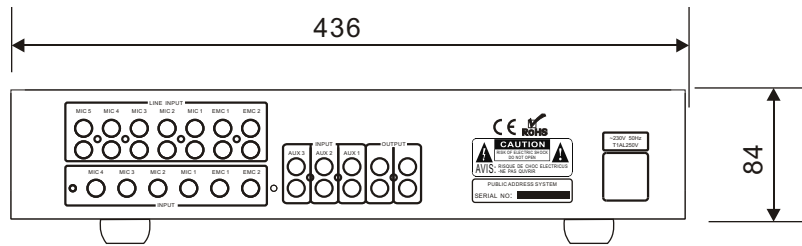
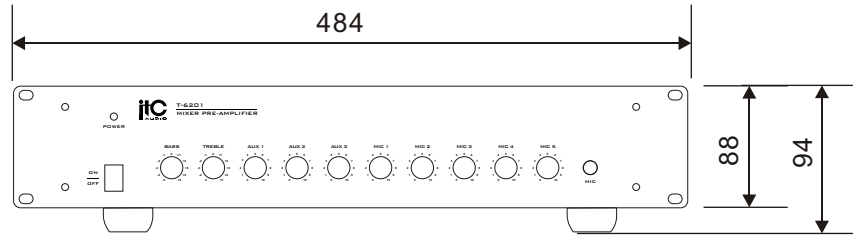

Keep the unit's all sides over 10 cm away from objects that may obstruct air flow to prevent the unit's internal temperature rise.

UNIT :mm

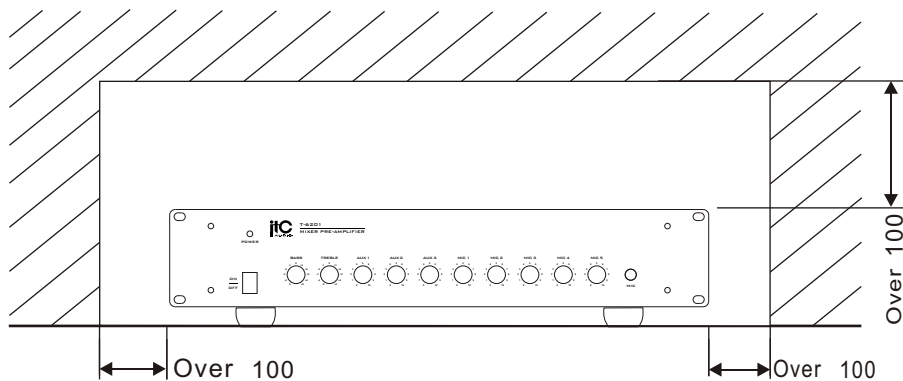

PUBLIC ADDRESS SYSTEM



Guangzhou ITC Electronic Technology Limited
[Http://www.itc-pa.com.cn](http://www.itc-pa.com.cn)