



PUBLIC ADDRESS SYSTEM

OPERATION MANUAL

T-30FP
T-60FP
T-120FP
MIXER AMPLIFIER



Please follow the instructions in this manual to obtain the optimum results from this unit. We also recommend that you keep this manual handy for future reference.

TABLE OF CONTENTS

1. SAFETY PRECAUTIONS	3
2. GENERAL DESCRIPTION	5
3. FEATURES	5
4. NOMENCLATURE AND FUNCTIONS	
4.1 Front Panel	6
4.2 Rear Panel.....	7
5. CONNECTIONS	
5.1. Speaker Connections	8
5.2. XLR Connections	8
6. MACHINE OPERATION	9
7. APPLICATIONS	10
8.SPECIFICATIONS	11
9.DIMENSIONAL DIAGRAM	13

1. SAFETY PRECAUTIONS

- Be sure to read the instructions in this section carefully before use.
- Make sure to observe the instructions in this manual as the conventions of safety symbols and messages regarded as very important precautions are included.
- We also recommend you keep this instruction manual handy for future reference.

Safety Symbol and Message Conventions

Safety symbols and messages described below are used in this manual to prevent bodily injury and property damage which could result from mishandling. Before operating your product, read this manual first and understand the safety symbols and messages so you are thoroughly aware of the potential safety



WARNING

Indicates a potentially hazardous situation which, if mishandled, could result in death or serious personal injury.



CAUTION

Indicates a potentially hazardous situation which, if mishandled, could result in moderate or minor personal injury, and/or property damage.



WARNING

When Installing the Unit

- Do not expose the unit to rain or an environment where it may be splashed by water or other liquids, as doing so may result in fire or electric shock.
- Use the unit only with the voltage specified on the unit. Using a voltage higher than that which is specified may result in fire or electric shock.
- Do not cut, kink, otherwise damage nor modify the power supply cord. In addition, avoid using the power cord in close proximity to heaters, and never place heavy objects -- including the unit itself -- on the power cord, as doing so may result in fire or electric shock.
- Be sure to replace the unit's terminal cover after connection completion. Because high voltage is applied to the speaker terminals, never touch these terminals to avoid electric shock.
- Be sure to ground to the safety ground (earth) terminal to avoid electric shock. Never ground to a gas pipe as a catastrophic disaster may result.
- Avoid installing or mounting the unit in unstable locations, such as on a rickety table or a slanted surface. Doing so may result in the unit falling down, causing personal injury and/or property damage.

When the Unit is in Use

- Should the following irregularity be found during use, immediately switch off the power, disconnect the power supply plug from the AC outlet and contact your nearest **ITC** dealer. Make no further attempt to operate the unit in this condition as this may cause fire or electric shock.
 - If you detect smoke or a strange smell coming from the unit.
 - If water or any metallic object gets into the unit
 - If the unit falls, or the unit case breaks
 - If the power supply cord is damaged (exposure of the core, disconnection, etc.)
 - If it is malfunctioning (no tone sounds.)
- To prevent a fire or electric shock, never open nor remove the unit case as there are high voltage components inside the unit. Refer all servicing to your nearest **ITC** dealer.
- Do not place cups, bowls, or other containers of liquid or metallic objects on top of the unit. If they accidentally spill into the unit, this may cause a fire or electric shock.
- Do not insert nor drop metallic objects or flammable materials in the ventilation slots of the unit's cover, as this may result in fire or electric shock.

1. SAFETY PRECAUTIONS

CAUTION

When Installing the Unit

- Never plug in nor remove the power supply plug with wet hands, as doing so may cause electric shock.
- When unplugging the power supply cord, be sure to grasp the power supply plug; never pull on the cord itself. Operating the unit with a damaged power supply cord may cause a fire or electric shock.
- When moving the unit, be sure to remove its power supply cord from the wall outlet. Moving the unit with the power cord connected to the outlet may cause damage to the power cord, resulting in fire or electric shock. When removing the power cord, be sure to hold its plug to pull.
- Do not block the ventilation slots in the unit's cover. Doing so may cause heat to build up inside the unit and result in fire.
- Avoid installing the unit in humid or dusty locations, in locations exposed to the direct sunlight, near the heaters, or in locations generating sooty smoke or steam as doing otherwise may result in fire or electric shock.

When the Unit is in Use

- Do not place heavy objects on the unit as this may cause it to fall or break which may result in personal injury and/or property damage. In addition, the object itself may fall off and cause injury and/or damage.
- Make sure that the volume control is set to minimum position before power is switched on. Loud noise produced at high volume when power is switched on can impair hearing.
- Do not operate the unit for an extended period of time with the sound distorting. This is an indication of a malfunction, which in turn can cause heat to generate and result in a fire.
- Contact your **ITC** dealer as to the cleaning. If dust is allowed to accumulate in the unit over a long period of time, a fire or damage to the unit may result.
- If dust accumulates on the power supply plug or in the wall AC outlet, a fire may result. Clean it periodically. In addition, insert the plug in the wall outlet securely.
- Switch off the power, and unplug the power supply plug from the AC outlet for safety purposes when cleaning or leaving the unit unused for 10 days or more. Doing otherwise may cause a fire or electric shock.

An all-pole mains switch with a contact separation of at least 3 mm in each pole shall be incorporated in the electrical installation of the building.

2. GENERAL DESCRIPTION

ITC series of public address mixer amplifiers have power ratings from 30 to 120 watts RMS, these sleek, attractive units provide a compact solution for PA system amplification and distribution.

3. FEATURES

- Rated power:30W/60W/120W.
- AC and DC operation.
- Special Low Cut filter built-in.
- Level meter and power indicator.
- Phoenix connector for easy installation.
- 4 Aux input, with inter-lock to avoid blending.
- Built-in 2 tone and 4 tone chime two options.
- Pre OUT for other signal processing equipments.
- Individual input volume and master volume control.
- Current limiter, overloading, short circuit and thermal protection.
- With remote priority input to select background music when paging.
- 4 balanced XLR mic input with selectable priority and each with phantom power.
- Constant voltage 100V and 70V lines and low impedance 4 ohms and 8 ohms speaker terminal
- Constant voltage 100V and 70V lines and low impedance 4 ohms and 8 ohms speaker terminal 3. 4
Aux input, with inter-lock to avoid blending

4. NOMENCLATURE AND FUNCTIONS

4.1 FRONT PANEL

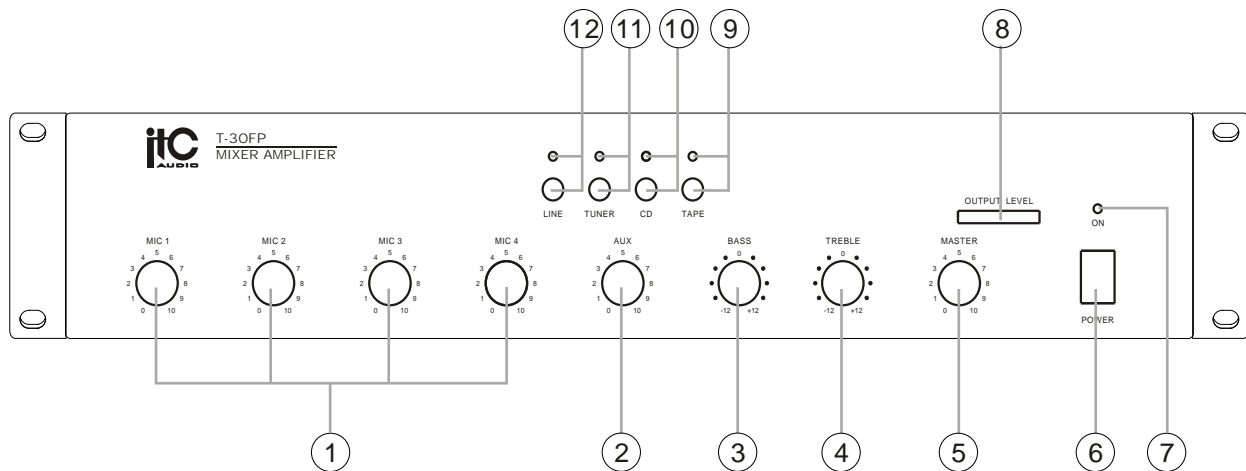

1. MIC1 \ MIC2 \ MIC3 \ MIC4

MIC volume control (MIC1/MIC2/MIC3/MIC4)

2. AUX

AUX volume control

3. BASS

Adjust bass response. Rotate clockwise to increase bass output and anticlockwise to reduce it.

4. TREBLE

Adjust treble response. Rotate clockwise to increase treble output and anticlockwise to reduce it.

5. MASTER

Master volume control

6. POWER SWITCH

On top of the opening Power

Press the end, power shut down

7. ON

Protection indicator

8. OUTPUT LEVEL

Power level indicator

9. TAPE

Select tape channel input keyswitch

10.CD

Select CD channel input keyswitch

11.TUNER

Select tuner channel input keyswitch

12.LINE

Select line channel input keyswitch

4.2 REAR PANEL

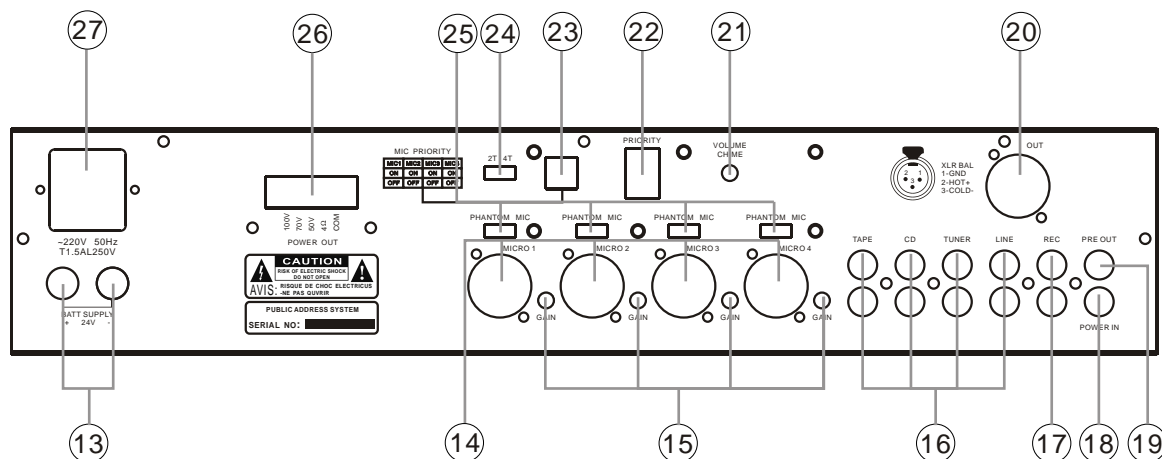

13.24V DC BATT SUPPLY

14.MIC(1~4)

MICRO(1~4)microphone input

15.GAIN

MICRO(1~4) microphone gain control

16.LINE

Audio source interface

17.REC

To recorder interface

18.POWER IN

Form effect return interface

19.PRE OUT

To effect input interface

20.OUT

Audio output

21.CHIME VOLUME

Chime volume control

22.PRIORITY

Priority control port

23.DIPSWITCH MIC POSITIONS (1-4)

MIC PRIORITY

MIC1	MIC2	MIC3	MIC4
ON	ON	ON	ON
OFF	OFF	OFF	OFF

When set to the "OFF" position, PHANTOM POWER is turned off on INPUTS 1-4. When set to the "ON" position, PHANTOM POWER (24V DC) is available on INPUTS 1-4 (mic position only).

24.CHIME(2 Tone\4 Tone)

Chime(2 Tone\4 Tone) volume Control

25.PHANTOM POWER

MIC(1~4) phantom power select switch

26.SPEAKER TERMINALS

Connectors for 4 ohms or 50V \ 70V and 100V speaker

27.~220V/50Hz AC power input

5. CONNECTIONS

5.1 SPEAKER CONNECTIONS

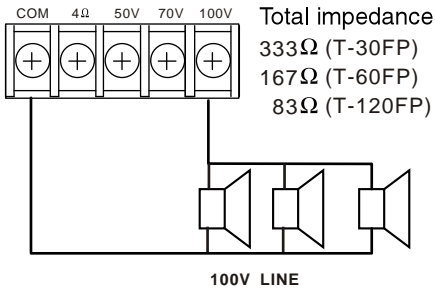
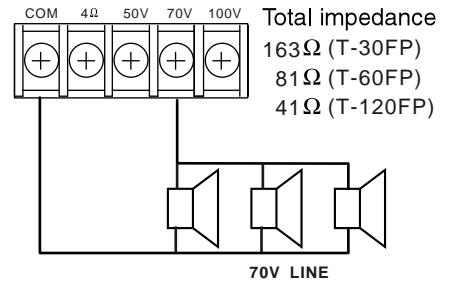
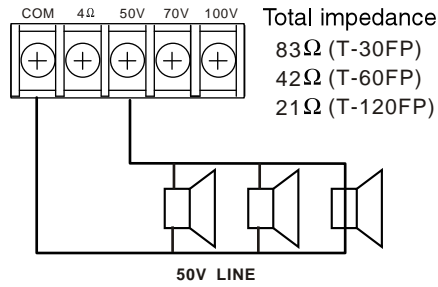
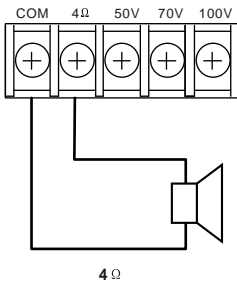

Notes

- Both the 4 Ω and 50V\70V\100 V terminals cannot be used at the same time.
- Impedances indicated in the figures represent the total speaker system (load) impedances.

⚠ WARNING

Be sure to attach the supplied terminal cover after connection completion. Because high voltage is applied to the speaker terminals, never touch these terminals to avoid electric shock.

5.2 XLR CONNECTIONS

Combined XLR (female)/phone jack connectors.

Usable connectors and plugs

- XLR type male connector

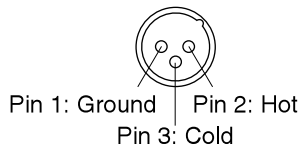

- Phone plug

Sleeve: Ground

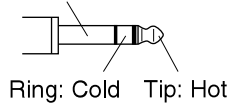

6. MACHINE OPERATION

OPERATION ATTENTION

- 1 Do not open and close the machine frequently. Reopen should be after 10 seconds.
- 2 Power supply should match up to the machine.
- 3 The machine outfit with ground line, so please plug on the connected-ground wire-net
- 4 As formidable shock or impact on machine such as (thunder shock, halfway signal pause, excess rated signal input or other interference), the machine will auto-check and reopen automatically.

8. SPECIFICATIONS

MIXER AMPLIFIER			
MODEL	T-30FP	T-60FP	T-120FP
RATED POWER OUTPUT	30W	60W	120W
4 MICROPHONE INPUTS	XLR Balanced with phantom power		
SENSITIVITY	-50 /-2dB 2.5 /500 mV		
SIGNAL TO NOISE RATIO	>68 dB		
FREQUENCY RESPONSE	40 / 17.000 Hz (-3 dB)		
PHANTOM POWER	+48 V		
4 AUXILIARY INPUTS			
TUNER AND TAPE INPUTS SENSIVITY/IMPEDANCE	200 mV/47 K Ω		
CD AND LINE INPUTS SENSIVITY/IMPEDANCE	500 mV/47 K Ω		
SIGNAL TO NOISE RATIO	90 dB		
FREQUENCY RESPONSE	40/18.000Hz (-3 dB)		
CONTROL			
BASS	\pm 12 dB		
TREBLE	\pm 12 dB		
CHIME	2 tone and 4 tone options		
OUTPUTS			
OUTPUT ELECTRO/IMPEDANCE	775 mV/47K Ω		
OUTPUT REC/IMPEDANCE	200 mV/1K Ω		
DISTORTION	< 0.1%		
OPERATING CONDITION			
AC MAINS INPUT	220V A C 50Hz, 24V DC(optional)		
DIMENSIONS (D X W X H)mm	484X340X88		484X380X88
POWER CONSUMPTION	80W	90W	120W
WEIGHT	9.2Kg	10.1Kg	10.9Kg

9. DIMENSIONAL DIAGRAM

UNIT :mm

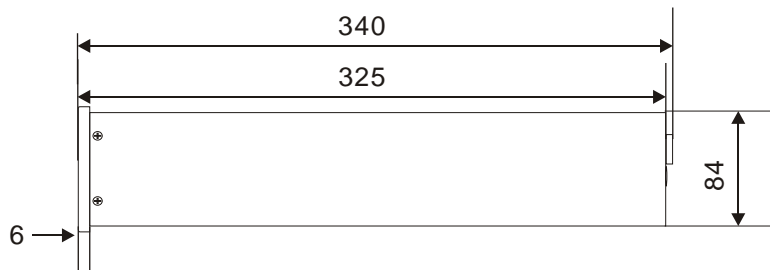
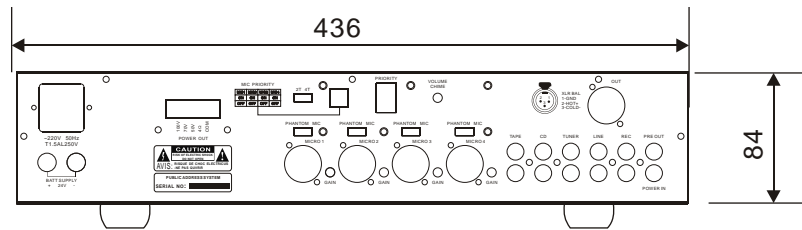
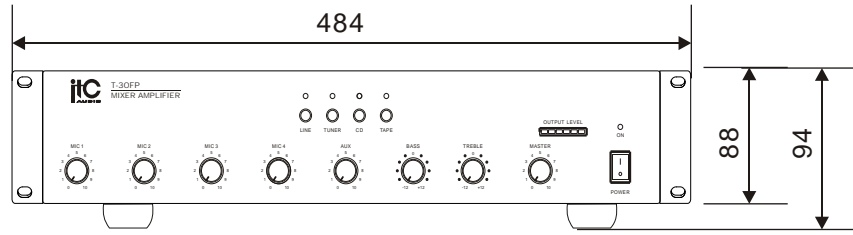

Keep the unit's all sides over 10 cm away from objects that may obstruct air flow to prevent the unit's internal temperature rise.

UNIT :mm

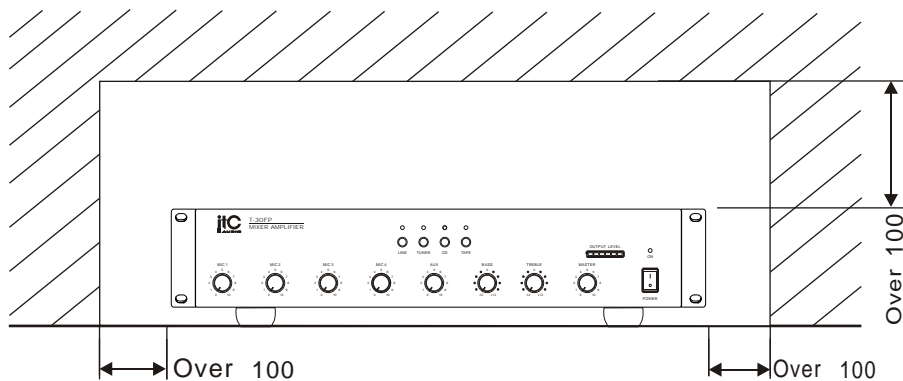

PUBLIC ADDRESS SYSTEM



Guangzhou ITC Electronic Technology Limited
[Http://www.itc-pa.com.cn](http://www.itc-pa.com.cn)