



PUBLIC ADDRESS SYSTEM

OPERATION MANUAL

T-328 PAGING STATION



Please follow the instructions in this manual to obtain the optimum results from this unit. We also recommend that you keep this manual handy for future reference.

TABLE OF CONTENTS

1. SAFETY PRECAUTIONS	3
2. GENERAL DESCRIPTION	5
3. FEATURES	5
4. NOMENCLATURE AND FUNCTIONS	
4.1 Front Panel	6
4.2 Rear Panel.....	7
5. CONNECTIONS	8
6. APPLICATIONS	9
7. ADDRESS SET	11
8. BLOCK DIAGRAM	13
9. SPECIFICATIONS	14
10. DIMENSIONAL DIAGRAM	15

1. SAFETY PRECAUTIONS

- Be sure to read the instructions in this section carefully before use.
- Make sure to observe the instructions in this manual as the conventions of safety symbols and messages regarded as very important precautions are included.
- We also recommend you keep this instruction manual handy for future reference.

Safety Symbol and Message Conventions

Safety symbols and messages described below are used in this manual to prevent bodily injury and property damage which could result from mishandling. Before operating your product, read this manual first and understand the safety symbols and messages so you are thoroughly aware of the potential safety



WARNING

Indicates a potentially hazardous situation which, if mishandled, could result in death or serious personal injury.



CAUTION

Indicates a potentially hazardous situation which, if mishandled, could result in moderate or minor personal injury, and/or property damage.



WARNING

When Installing the Unit

- Do not expose the unit to rain or an environment where it may be splashed by water or other liquids, as doing so may result in fire or electric shock.
- Use the unit only with the voltage specified on the unit. Using a voltage higher than that which is specified may result in fire or electric shock.
- Do not cut, kink, otherwise damage nor modify the power supply cord. In addition, avoid using the power cord in close proximity to heaters, and never place heavy objects -- including the unit itself -- on the power cord, as doing so may result in fire or electric shock.
- Be sure to replace the unit's terminal cover after connection completion. Because high voltage is applied to the speaker terminals, never touch these terminals to avoid electric shock.
- Be sure to ground to the safety ground (earth) terminal to avoid electric shock. Never ground to a gas pipe as a catastrophic disaster may result.
- Avoid installing or mounting the unit in unstable locations, such as on a rickety table or a slanted surface. Doing so may result in the unit falling down, causing personal injury and/or property damage.

When the Unit is in Use

- Should the following irregularity be found during use, immediately switch off the power, disconnect the power supply plug from the AC outlet and contact your nearest **ITC** dealer. Make no further attempt to operate the unit in this condition as this may cause fire or electric shock.
 - If you detect smoke or a strange smell coming from the unit.
 - If water or any metallic object gets into the unit
 - If the unit falls, or the unit case breaks
 - If the power supply cord is damaged (exposure of the core, disconnection, etc.)
 - If it is malfunctioning (no tone sounds.)
- To prevent a fire or electric shock, never open nor remove the unit case as there are high voltage components inside the unit. Refer all servicing to your nearest **ITC** dealer.
- Do not place cups, bowls, or other containers of liquid or metallic objects on top of the unit. If they accidentally spill into the unit, this may cause a fire or electric shock.
- Do not insert nor drop metallic objects or flammable materials in the ventilation slots of the unit's cover, as this may result in fire or electric shock.

1. SAFETY PRECAUTIONS

CAUTION

When Installing the Unit

- Never plug in nor remove the power supply plug with wet hands, as doing so may cause electric shock.
- When unplugging the power supply cord, be sure to grasp the power supply plug; never pull on the cord itself. Operating the unit with a damaged power supply cord may cause a fire or electric shock.
- When moving the unit, be sure to remove its power supply cord from the wall outlet. Moving the unit with the power cord connected to the outlet may cause damage to the power cord, resulting in fire or electric shock. When removing the power cord, be sure to hold its plug to pull.
- Do not block the ventilation slots in the unit's cover. Doing so may cause heat to build up inside the unit and result in fire.
- Avoid installing the unit in humid or dusty locations, in locations exposed to the direct sunlight, near the heaters, or in locations generating sooty smoke or steam as doing otherwise may result in fire or electric shock.

When the Unit is in Use

- Do not place heavy objects on the unit as this may cause it to fall or break which may result in personal injury and/or property damage. In addition, the object itself may fall off and cause injury and/or damage.
- Make sure that the volume control is set to minimum position before power is switched on. Loud noise produced at high volume when power is switched on can impair hearing.
- Do not operate the unit for an extended period of time with the sound distorting. This is an indication of a malfunction, which in turn can cause heat to generate and result in a fire.
- Contact your **ITC** dealer as to the cleaning. If dust is allowed to accumulate in the unit over a long period of time, a fire or damage to the unit may result.
- If dust accumulates on the power supply plug or in the wall AC outlet, a fire may result. Clean it periodically. In addition, insert the plug in the wall outlet securely.
- Switch off the power, and unplug the power supply plug from the AC outlet for safety purposes when cleaning or leaving the unit unused for 10 days or more. Doing otherwise may cause a fire or electric shock.

An all-pole mains switch with a contact separation of at least 3 mm in each pole shall be incorporated in the electrical installation of the building.

2. GENERAL DESCRIPTION

T-328 Series paging station is equipped with priority function. They are designed to suit all PA System application in schools, homes, offices and stores.

3. FEATURES

1. Zone selection Push the switch for one zone or all zone and the zone led turn on.
2. Announcement After selecting the zone where to play the announcement, Keep pushing the talk button, the led turn on , the internal chime play,and the user could proceed with the announcement.If at the same time another connected microphone base is already making an announcement(and therefore the line is already busy), the talk led start blinking.
3. Activation message 3 After selecting the zones, open alarm switch. Protection and push the button. Base of T-6245 setting, the system plays the message once or continuously till the alarm switch is not push back.
4. Priority Microphone base has priority on music and on recorded Message.
5. Recorded messages Three different messages,60 seconds max each,could be recorded.the first and second message are activate bycontact play message on T-6245 and they go to all zones. The third message could be only activated by microphone base console and it goes only in the pre-selected zone.messages have priority on all music sources.
6. Maximum can connect with 6pcs T-328

4. NOMENCLATURE AND FUNCTIONS

4.1 FRONT PANEL

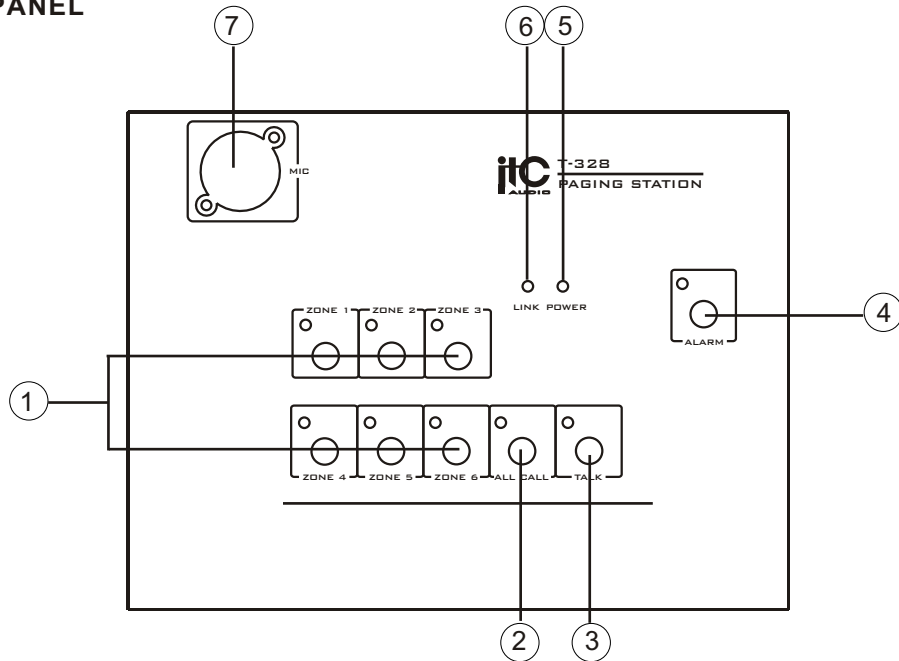

1. ZONE(1~6)

N.6 zone activation switches with led (see picture n.1 for possible labels solution)

2. ALL CALL

N.1 activation switch for all zones with led

3. TALK

N.1 microphone activation push button (talk) with led (in case more microphone bases require to talk at the same time, the first base get the line and all the others will have the led blinking)

4. ALARE

N.1 alarm message activation switch for pre-selected zone. (This switch with led must be protected ,press this button two seconds to activate alarm message)

5. POWER

Power indicator

6. LINK

Link indicator

7. MIC

N.1 electret microphone

4.2 REAR PANEL

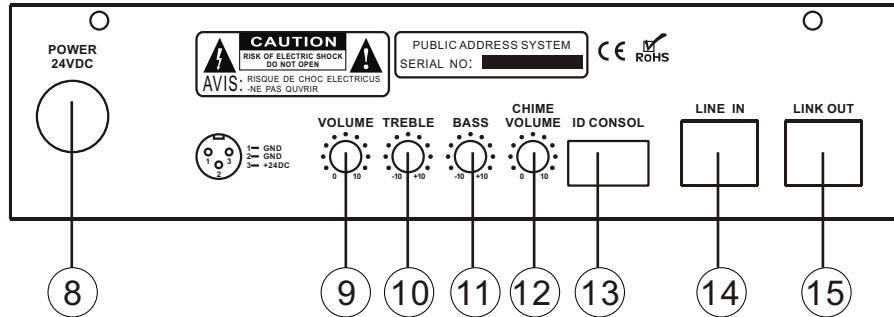

8. 24V DC POWER SUPPLY

24 Vdc power connection with secure screw for a potential external power transformer.

This 24V DC power transformer should be used when the distance (the distance could vary based on cable section) between the microphone base and T-328 is too much for the 24 Vdc provided by RJ45 connection. The connection of the external power supply disable the 24 Vdc provided by T-328.

9. VOLUME

Volume control output

10. TREBLE

Adjust treble response. Rotate clockwise to increase treble output and anticlockwise to reduce it.

11. BASS

Adjust bass response. Rotate clockwise to increase bass output and anticlockwise to reduce it.

12. CHIME

Volume chime control

13. ID CONSOL

Dip-switches for microphone base ID (from 1 to 6)

14. LINE IN

Rj45 port for connection to T-328.

Two wires are used for 24 Vdc power provided by T-328, two wires for the data bus 485 and 3 wires for 0dB microphone signal.

15. LINK OUT

Connected to the next T-328

5. CONNECTIONS

■ NETWORK CONNECTION LINE

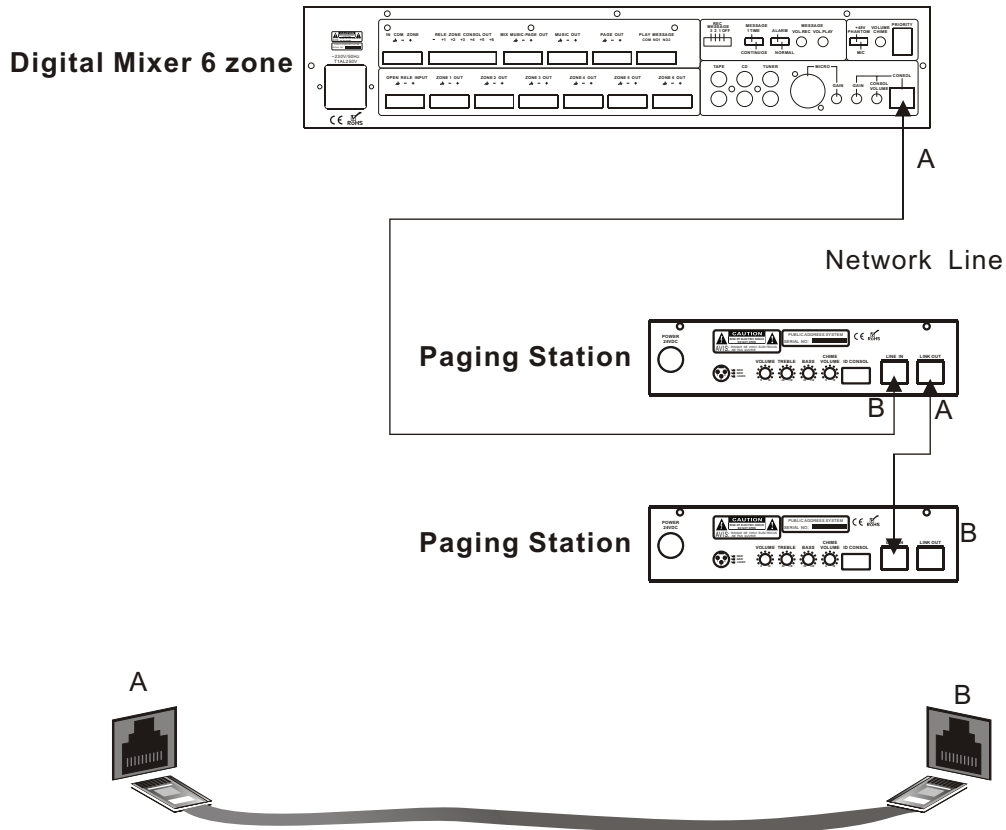

■ NET PRODUCTION LINE METHOD



A: 1 Blue 2 White Blue 3 Brown 4 White Brown 5 Orange 6 White Orange
7 Green 8 White Green

B: 1 Blue 2 White Blue 3 Brown 4 White Brown 5 Orange 6 White Orange
7 Green 8 White Green

⚠ Note: Network lines must adopt the five categories of twisted-pair with double-layer shielding, RJ45 connectors must be used with shielded connector.

6. APPLICATIONS

1 amplifier for music 1 amplifier for voice for 6 zone

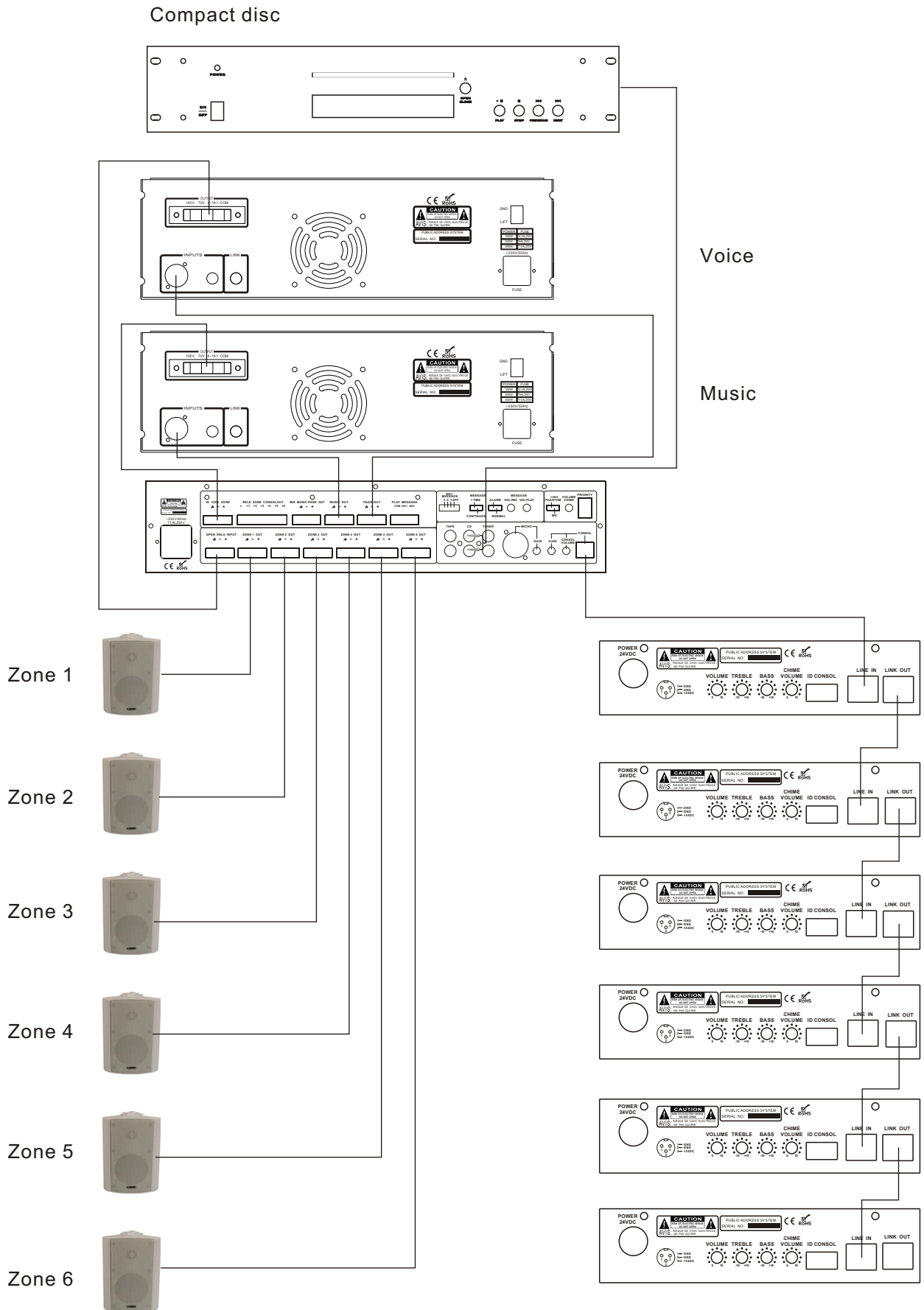

6 amplifier one for each zone

Compact disc

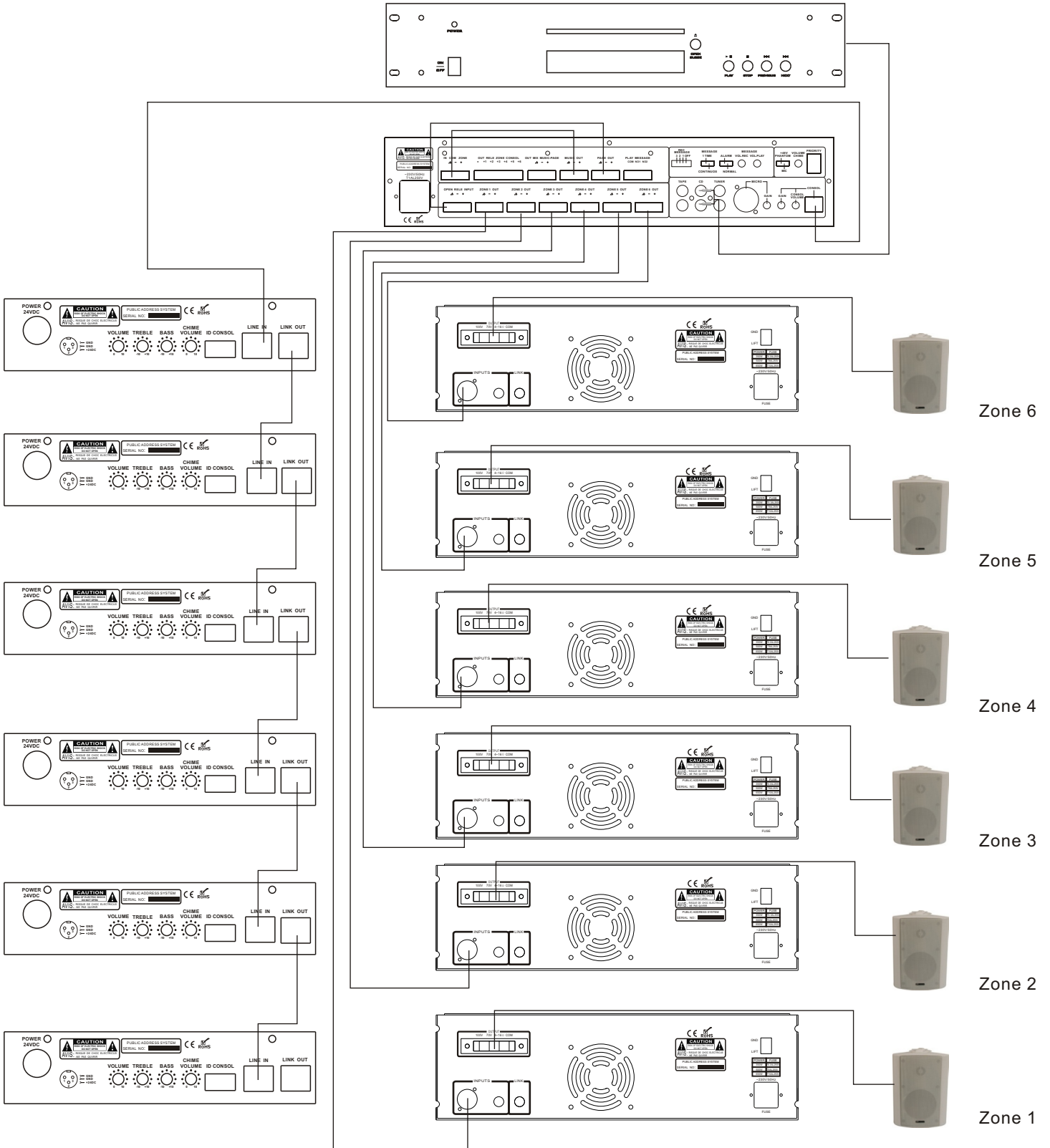

7.ADDRESS SET





ID CONSOL ADDRESS SET





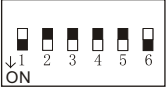
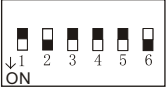
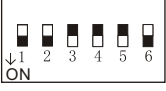
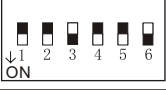
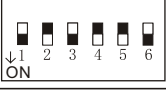
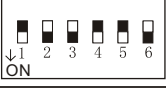
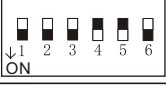

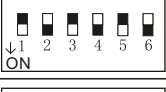
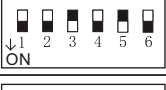
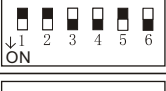
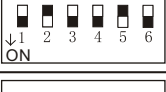
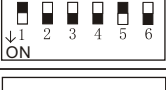
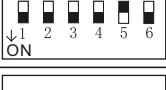

ADDRESS	DEFINITION
1	
2	
3	
4	
5	
6	
7	
8	
9	
10	
11	
12	
13	
14	
15	
16	

ADDRESS	DEFINITION
17	
18	
19	
20	
21	
22	
23	
24	
25	
26	
27	
28	
29	
30	
31	
32	

ADDRESS SET

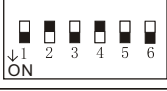
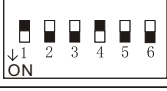
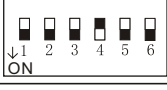
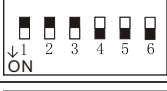
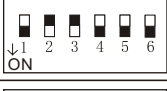
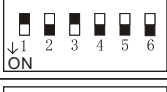
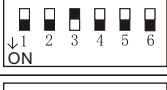
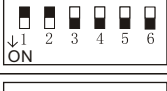
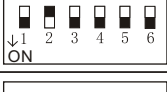
ID CONSOL ADDRESS SET

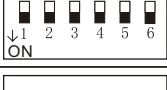
ADDRESS	DEFINITION
33	
34	
35	
36	
37	
38	
39	
40	
41	
42	
43	
44	
45	
46	
47	
48	

ADDRESS	DEFINITION
49	
50	
51	
52	
53	
54	
55	
56	
57	
58	
59	
60	
61	
62	
63	
64	

8. BLOCK DIAGRAM

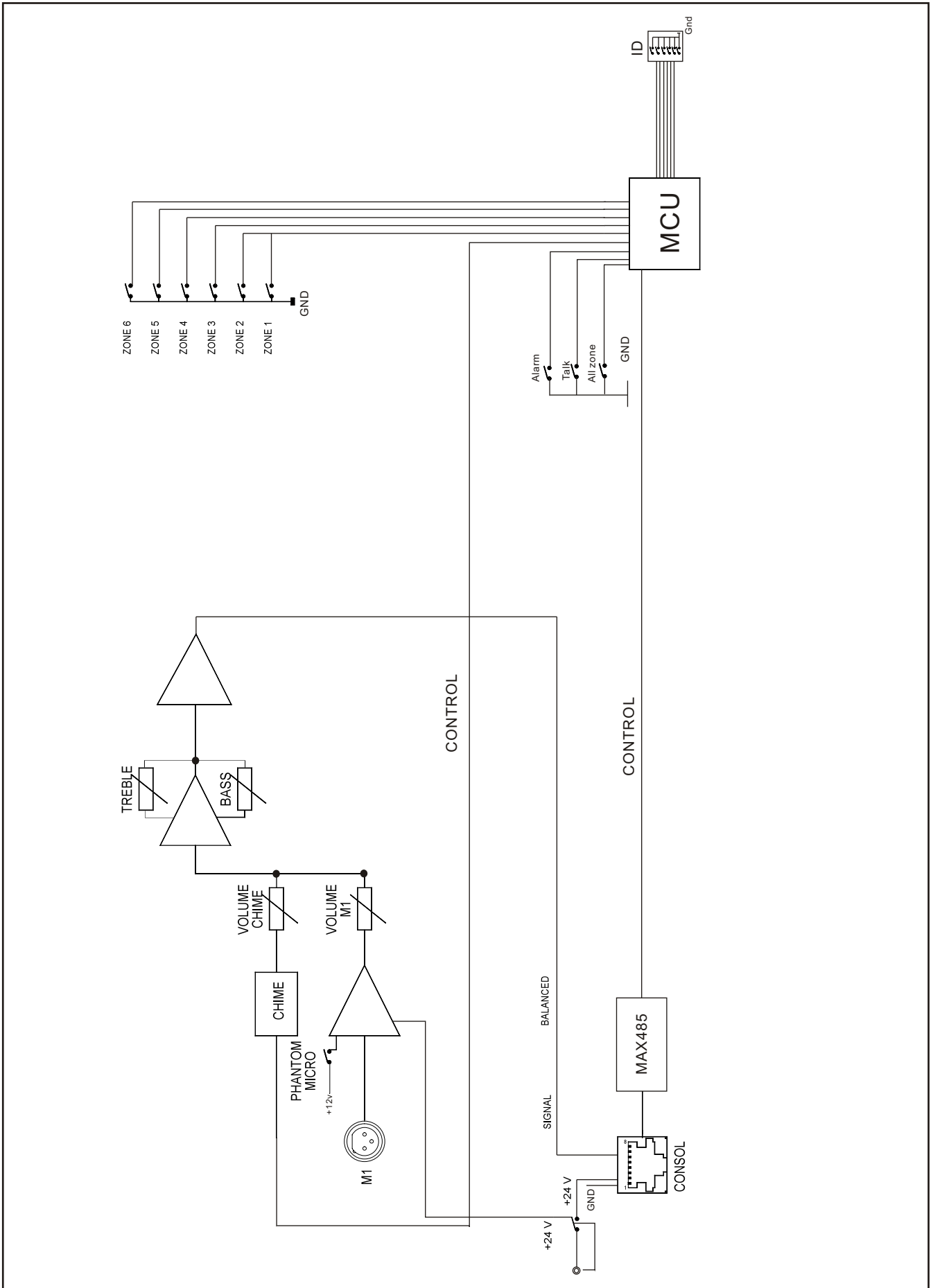

9. SPECIFICATIONS

Model	T-328
Sensitivity	-50 / -2 dB 2, 5 / 500 mV
S/N ratio	>68dB
Frequency response	100/17.000Hz(-3dB)
Phantom power	12V
Bass	± 12 dB
Treble	± 12 dB
Chime	2 tone active for contact free in priority and BGM
Normal distortion	>0.1%
Main power supply	24 DC
Dimension(mm)	230X150X56
Weight	0.96Kg
Max number of microphone bases	6

10. DIMENSIONAL DIAGRAM

UNIT :mm

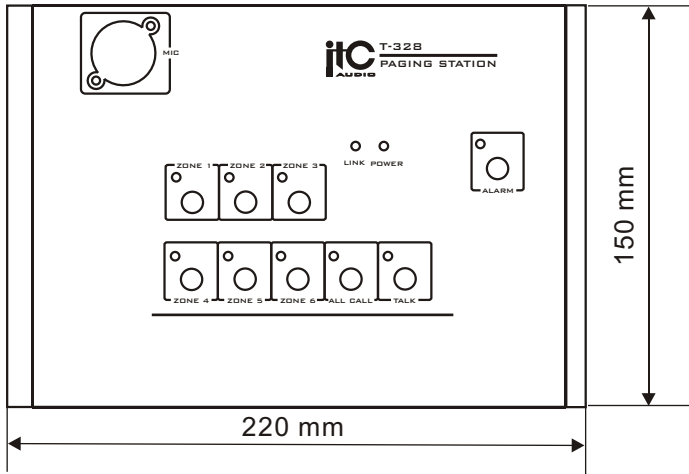

Front Panel

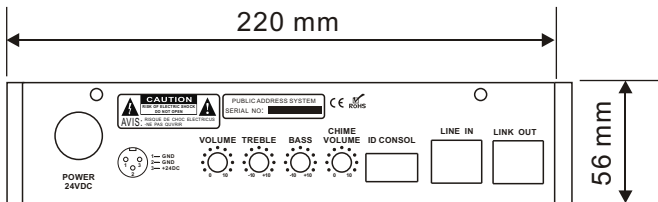

Rack Panel

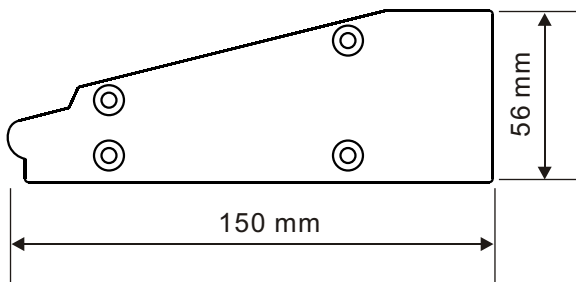

Side Panel

PUBLIC ADDRESS SYSTEM

