

5 Zones Mixer Amplifier TI-650

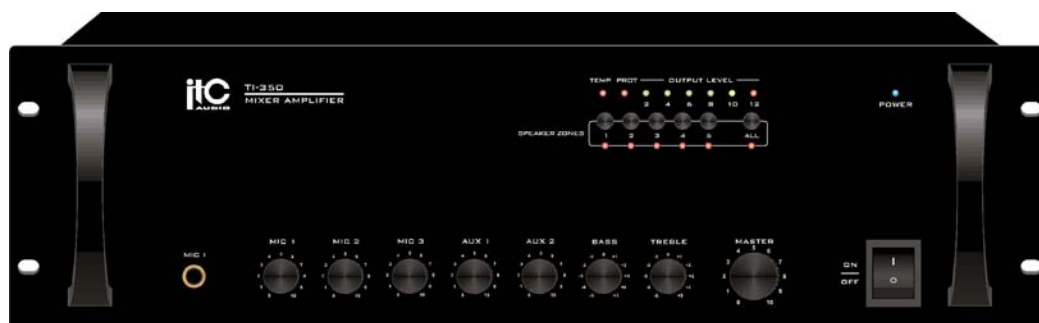

650W 100V 5 zone

Descriptions

The basic public address 5 zone mixer amplifiers have power ratings 650W.

They are featured of 3 microphone inputs, 2 aux inputs and 2 EMC inputs.

Priority muting is achieved via EMC1-2 for overriding other inputs except Mic 1 on front panel.

Individual gain controls are provided for Mic 1-3 and Aux 1-2, bass and treble controls and master volume control are provided for overall tone control.

70V, 100V and low impedance 4-16ohms speaker outputs are provided.

Extensive protection from short-circuit, overload and high temp.

Features

- * Mixer amplifier for paging and background music system
- * Rated power 650W
- * 2U rack mount (less than 350W) and 3U rack mount design
- * 70V, 100V and low impedance 4-16ohm speaker output
- * 5 zone and all zone speaker terminals
- * Three Mic inputs by phone jack type
- * Mic 1 with VOX priority and VOX level on front panel
- * Mic 2-3 by phone jack on rear panel
- * Two Aux Inputs and 2 line inputs for spare use
- * Two EMC priority inputs
- * EMC1 has priority over all inputs except MIC1
- * Mic 1-3, Aux 1-2 and master volume controls and bass/treble tone control
- * Short circuit, overload and high temp protection

Optional

- * DC 24V available on less than 500W model
- * Panel with/without handhold
- * Faults monitoring module, it can output short circuit signal to achieve main/spare amplifier switch

Specifications

Model	TI-650
Rated Power Output	650W
Speaker Outputs	70V, 100V & 4~16Ω
Input Sensitivity & Impedance	MIC 1, 2, 3: 5mV/600Ω, Unbalanced phone jack input MIC 2, 3: 775mV/10KΩ, Unbalanced RCA input AUX 1, 2: 350mV/10KΩ, Unbalanced RCA input EMC: 775mV/10KΩ, Unbalanced RCA input
Output Sensitivity & Impedance	MIX OUT: 1000mV/470Ω, Unbalanced RCA output
Tone	Bass: ± 10dB at 100Hz Treble: ± 10dB at 10KHz
Frequency Response	50Hz~16KHz(+1dB, -3dB)
S/N Ratio	MIC 1, 2, 3: 66dB; AUX 1, 2: 80dB
THD	Less than 0.5% at 1KHz, 1/3 rated power
Muting Function	MIC 1 overrides other input signals with 0-30 dB attenuation
Crosstalk	≤ 50dB
Cooling	Fan automatically start up when temp reaches 55°C
Protection	High temp, overload & short-circuit
Power Supply	~110V/60Hz or ~230V/50Hz or DC 24V
Power Consumption	900W
Weight	23.7Kg
Dimensions	484×385×132mm
Finish	Panel: aluminum plate, black Case: steel plate, black

Rear Panel

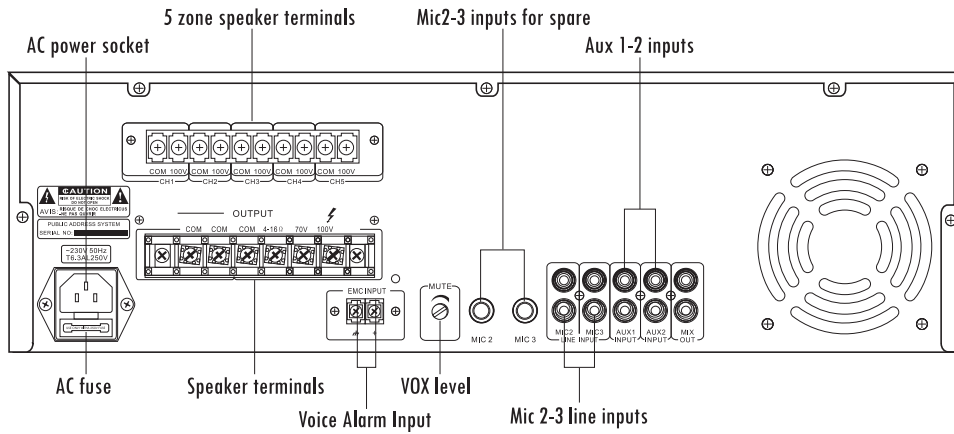

Connections

